

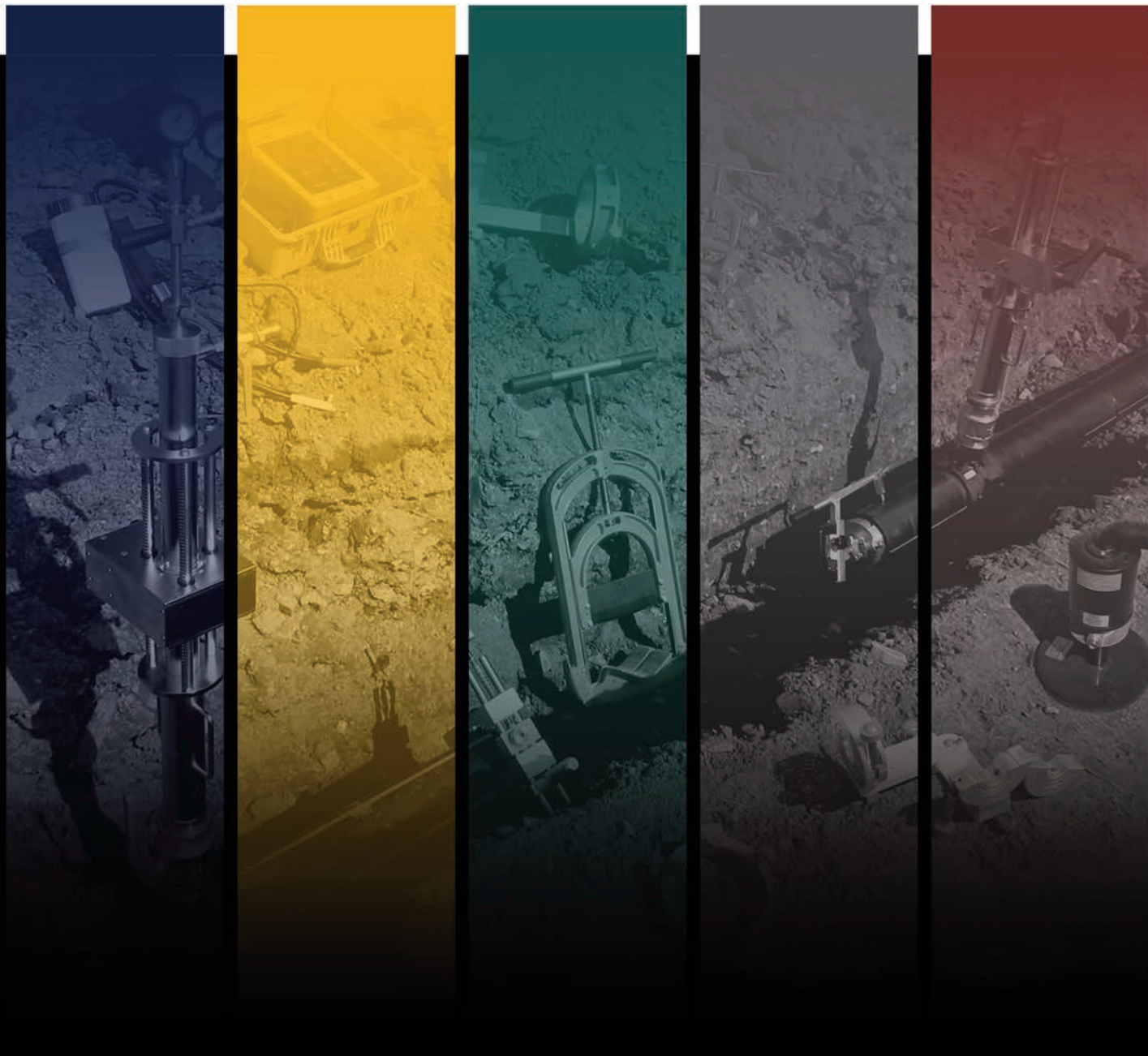

*Delivering
Natural Gas
Innovation...*



**TOOLING & DISTRIBUTION
PRODUCTS CATALOG**

M6

WHAT'S NEW...



**PERC FREEDOM BATTERY
ELECTROFUSION PROCESSOR**

Page 5



**UNIVERSAL ELECTROFUSION
FITTING ADAPTER**

Page 7

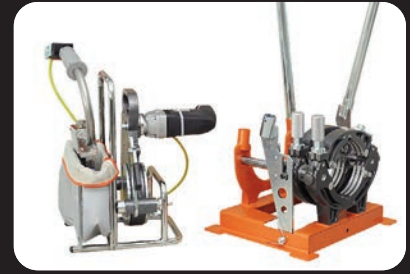

**RITMO DELTA 160M BUTT
FUSION MACHINE**

Page 7



**RIBBON READER
ELECTROFUSION GAUGE**

Page 11



**ALIGNRITE MINI
ELECTROFUSION CLAMP**

Page 15



**UTILITY LOGIC VALVE BOX
LOGIC SYSTEM**

Page 67



**RETZ REGULATOR
ADJUSTING TOOL**

Page 70



**HALO VALVE
GAS FLOW BREAKAWAY**

Page 70



CROSS COMPRESSION SYSTEMS

Page 73



*Reach out to your
Mulcare Sales
Person for a
demonstration of
these innovative
new products!*



PLASTIC PIPE JOINING4



PLASTIC PIPE SQUEEZE & CUTTING20



GAS MAIN TAPPING28



SERVICE RENEWAL.....32



VALVE TOOLING36



FLOW STOP OFF, BAGS & PLUGS.....40



STEEL & CAST IRON PIPE CUTTING, BEVELING & SQUEEZING46



POLYETHYLENE VALVES & FITTINGS.....50



MARKING, LOCATING & LEAK DETECTION54



SYSTEM PROTECTION60



METER SET TOOLS & COMPONENTS68



METHANE EMISSIONS REDUCTION72

Plastic Pipe Joining

*Mulcare offers everything you need
for all types of plastic pipe joining.*

PHOENIX AC POWERED ELECTROFUSION PROCESSOR

PHOENIX FREEDOM BATTERY OPERATED ELECTROFUSION PROCESSORS

BUTT FUSION EQUIPMENT

RITEGRAPE ELECTROFUSION PE PIPE SCRAPERS

ELECTROFUSION MEASUREMENT GAUGES

ALIGNRITE ELECTROFUSION ALIGNMENT CLAMPS

CHAMFER TOOLS

MECHANICAL JOINING

ALCOHOL WIPES

E-Z PROBE PYROMETER





PERC Phoenix Electrofusion Processors are universal barcode processors that can identify and fuse fittings from any electrofusion fitting manufacturer.

All processors come with these industry leading features:

- Longer 17' Output Cables
- Wide Array Barcode Scanner with GPS Option
- Unique High Visibility/Low Temp Displays
- Center Balanced Watertight Enclosure with Easy Carry Handle
- USB or Bluetooth Connectivity
- Resistor ID Tip Option
- Calibration Lockout Capability & Operator Traceability Functions
- Battery Charge Life Display & Fitting Capacity Calculation
- Field Calibration with AUTOCAL®
- CALABUNGA C³ Calibration Control Center Compatible
- Made in the USA



A donation will be made to Folds of Honor for every Freedom Processor sold



Ask your representative about our calibration and repair services

Call now to place an order
973-335-4800

MULCARE





PERC PHOENIX ELECTROFUSION PROCESSOR SPECIFICATIONS

| SPECIFICATION | AC | FREEDOM | FREEDOM Lt |
|------------------------------|--|-----------------------------|-----------------------------|
| Universal | YES | | |
| Operating Modes | Barcode, Manual & Resistor ID | | |
| Size | 20.625" x 16.875" x 8.125" | 20.5" x 11.5" X 8" | 19.125" x 15.5" X 7.5" |
| Weight | 48 lbs | 42 lbs | 21 lbs |
| Output Cable Length | 17 feet | 17 feet | 17 feet |
| Maximum Fitting Size | Any Fitting | 12" Couplings | 2" Couplings |
| Power Source | AC / Generator / Inverter | 32 Ah Lithium Ion Battery | 5 Ah Lithium Ion Battery |
| Supply Voltage | 97 VAC - 150 VAC | 120 VAC for charging only | 120 VAC for charging only |
| Recharging Time | N/A | 3.5 hours | 1.5 hours |
| Supply Frequency | 47 Hz - 70 Hz | 60 Hz for charging only | 60 Hz for charging only |
| Supply Waveform | Sine Wave or Square Wave | Sine Wave for charging only | Sine Wave for charging only |
| Output Voltage | 8 - 48 volts +/- 2% | | |
| Operating Temperature | 0° F - 120° F (optionally 0° F - 140° F) | | |
| High Visibility Display | 60 Lux* (33% greater) | | |
| Fusion Storage | 5000+ Fusions | | |
| Fitting Adapters Included | 4.0mm / 4.7mm / Resistor ID | | |
| Environmental Protection | IP54 Splash Proof | | |
| Download Port / Connectivity | USB / Bluetooth | | |
| Interface Compatibility | ControlPoint / EF Utilities | | |
| Calibration Interval | 1, 2 or 3 year (customer choice) | | |
| Warranty | 1 Year Standard (optional extended warranty) | | |

*Lux – A unit of measure for illuminance intensity which is a measure of how much luminance is spread over a given area

SMART SCANNER

- Scans barcodes with or without GPS capability.

| Model | Part # |
|------------------|--------|
| SmartScanner | 306519 |
| SmartScanner GPS | 306520 |



Ask your representative about our calibration and repair services





REPLACEMENT TIPS

- Screw in style for PERC Phoenix Processor.
- Older styles available. Please Call.

| Size | Fittings* | Part # |
|----------------|-------------------------------|--------|
| 4.0 mm (White) | Nupi Elofit, Innogaz, Friatec | 306698 |
| 4.7 mm (Black) | Central, MT Deason | 306699 |
| 4.7 mm (Black) | Central (Resistor ID) | 306701 |
| — | Wrench | 301506 |
| — | Marinco Adapter | 301787 |

Above is a guide only - Make sure fitting adaptors are a snug fit into fitting listed

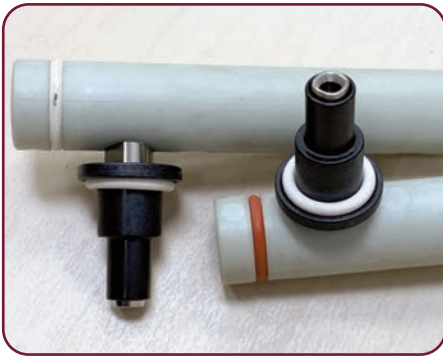

UNIVERSAL EF FITTING ADAPTER

- Universal adapter for 4.0mm and 4.7mm electrofusion fittings.
- Available with Resistor ID.

| Model | Part # |
|-----------------------------|--------|
| Set of 2 universal adapters | 306782 |



RITMO DELTA 160M MANUAL BUTT FUSION MACHINE

- Self-centering and precise jaws/clamps with fast insert system for sizes up to 4" IPS.
- Twin blade electric milling cutter with a safety micro-switch.
- Locking device helps to keep constant pressure during heat soak and fusion/cooling.
- Extractable heating plate with "Digital Dragon" the high precision electronic thermoregulator ($\pm 1^\circ$ C accuracy) with digital display and regulating buttons.
- Rigid fiberglass heating plate bag.

Please contact us for help in ordering.





NEW
quick blade
release lever and tapered
mandrel

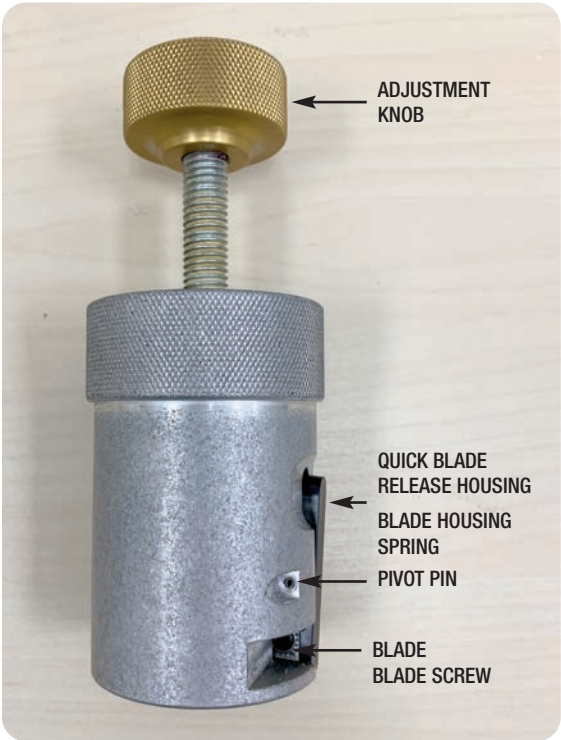

RITESCRAPER™ TUBING SCRAPERS V2

- Machined billet aluminum construction
- Floating 4-sided blade for consistent shaving depth even on coil or ovaled pipe
- Ideal for pipe prep on couplings and tees.
- 1/2" CTS through 2" IPS
- Tapered Mandrel for different wall thickness for same size tubing.

| Model | Tubing Size | Part # |
|----------------------------------|-------------|--------|
| RITESCRAPER Tubing Scraper V2 | 1/2" CTS | 308378 |
| | 3/4" IPS | 308379 |
| | 1" CTS | 308380 |
| | 1" IPS | 308381 |
| | 1-1/4" CTS | 308382 |
| | 1-1/4" IPS | 308384 |
| | 2" IPS | 308385 |

REPLACEMENT PARTS FOR ALL SIZES

| Adjustment Knob | Blade | Blade Screw |
|-----------------|--------|-------------|
| 304179 | 303653 | 303958 |

REPLACEMENT PARTS PER TOOL

| Blade Housing Spring (for 1/2" CTS - 1-1/4" IPS) | Quick Blade Release Housing (for 1/2" CTS - 1-1/4" IPS) | Blade Housing Pivot Pin (for 1/2" CTS - 1-1/4" IPS) | Blade Housing (for 2") | Blade Housing Bolt (for 2") |
|---|--|--|---------------------------|--------------------------------|
| 310543 | 310544 | 310545 | 310529 | 310530 |





NEW
design with
wider blade and
stronger hinge
point

RITESCRAPER™ SINGLE SIZE ROTARY SCRAPERS V3

- Machined billet aluminum construction
- Floating blade for consistent shaving depth even on coil or oveled pipe
- Same parts across all sizes
- Smaller profile for use in tight work areas
- 1-1/4" IPS through 12" main sizes

| Model | Pipe Size | Part # |
|--|------------|--------|
| RITESCRAPER Rotary Scraper V3 (Includes Bag) | 1-1/4" IPS | 308885 |
| | 2" IPS | 308817 |
| | 3" IPS | 308886 |
| | 4" IPS | 308818 |
| | 6" IPS | 308819 |
| | 8" IPS | 308887 |
| | 12" IPS | 308888 |

REPLACEMENT PARTS

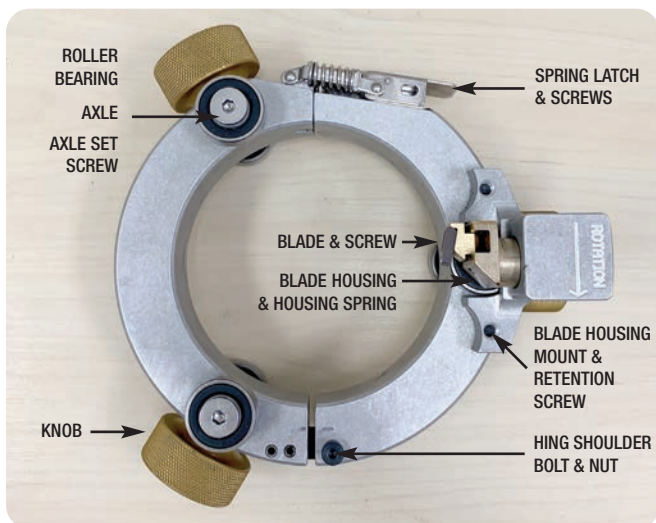

| Model | Part # |
|---------------------------------------|--------|
| Insert Stiffener for 1-1/4" & 2" Pipe | 303599 |

| Replacement Parts For All Size Scrapers | Part # |
|--|-------------|
| Blade (Single Edge) | 308854 |
| Blade Housing | 308880 |
| Blade Housing Mount | 308874 |
| Blade Housing Retention Screw | 308883 |
| Blade Housing Spring | 304585 |
| Hinge Shoulder Bolt & Nut | 308912 |
| Top Roller Bearing, Axle, Set Screw | Please Call |
| (2) Bottom Roller Bearings, Axles & Set Screws per tool size | Please Call |
| (3) Bottom Roller Bearings, Axles & Set Screws for 1-1/4" only | Please Call |
| Small Padded Bag (for 2" & 4") | 301961 |
| Large Padded Bag (for 6" & 8") | 301962 |
| X-Large Padded Bag (for 12") | 301956 |

| Replacement Parts For Previous Models | Part # |
|---------------------------------------|--------|
| Blade (4-sided) | 303653 |
| Blade Screw | 303958 |



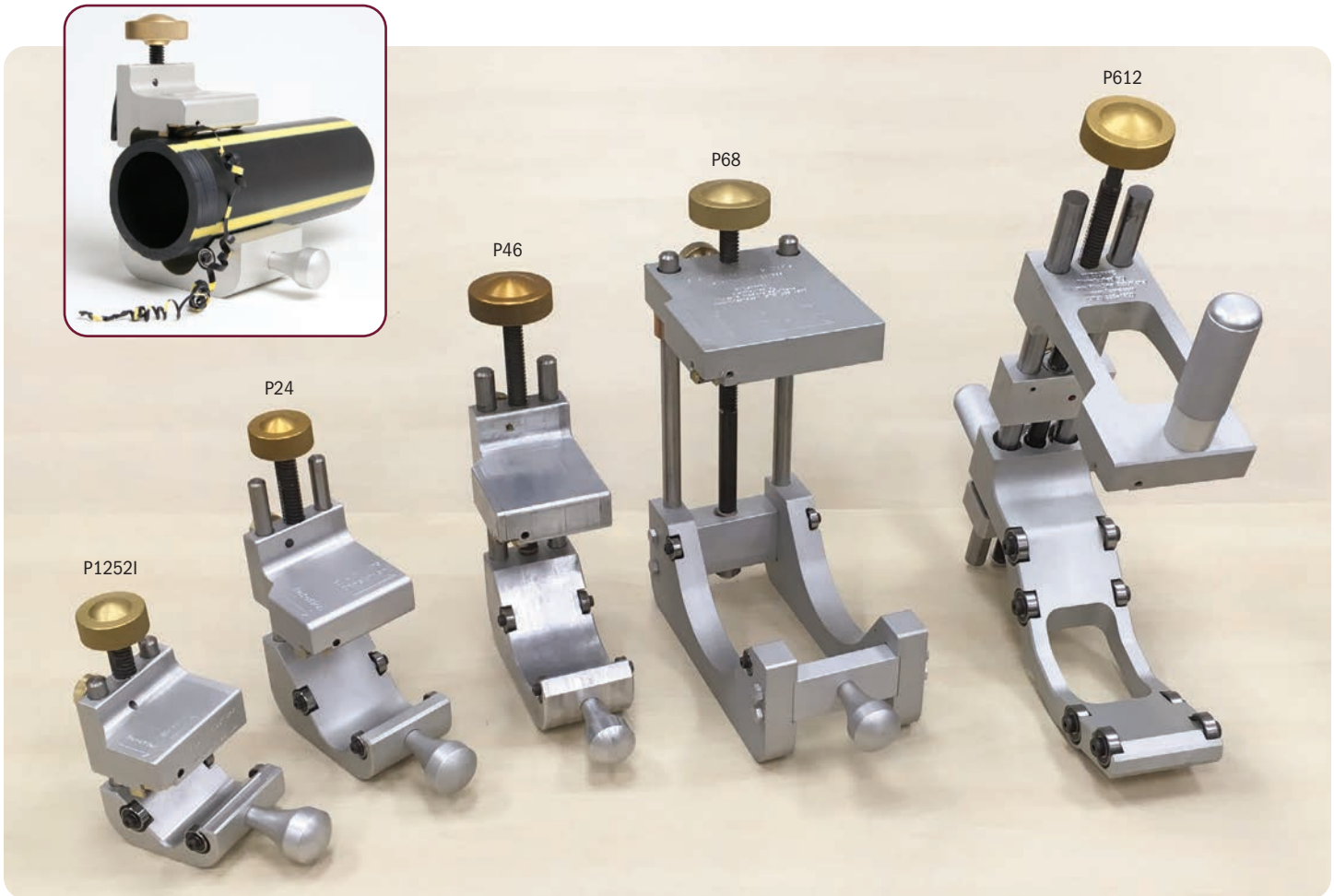

RITESCRAPE™ MULTI-SIZE SCRAPERS

- Machined billet aluminum construction
- Floating 4-sided blade for consistent shaving depth even on coil or oveled pipe
- Each tool handles multiple pipe sizes.
- 1-1/4" IPS through 12" main sizes available.

| Model | Pipe Size | Part # |
|---|-----------------|--------|
| RITESCRAPE Multi-Size Scraper | 1-1/4" – 2" IPS | 307206 |
| | 2" – 4" IPS | 307207 |
| | 4" – 6" IPS | 309588 |
| | 6" – 8" IPS | 303589 |
| | 6" – 12" IPS | 310415 |
| Carrying Case for 2" – 4" and 6" – 8" IPS | | 304215 |

RITESCRAPE™ MULTI-SIZE SCRAPERS REPLACEMENT PARTS

| Tool | Adjustment Knob | Adjustment Screw | Lock Knob | Lock Insert | Housing | Blade | Housing Spring | Blade Screw | Roller Bearing | Post | Shoulder Bolt |
|-----------------|-----------------|------------------|-----------|-------------|---------|--------|----------------|-------------|----------------|--------|---------------|
| 1-1/4" – 2" IPS | 304179 | 309572 | 303964 | 304178 | 303957 | 303653 | 303959 | 303958 | 303961 | 310105 | 303962 |
| 2" – 4" IPS | | 310104 | | | | | | | | 304114 | |
| 4" – 6" IPS | | 304416 | | | | | | | | 310146 | |
| 6" – 8" IPS | | 303841 | | | | | | | | 310075 | |
| 6" – 12" IPS | 310106 | 310269 | 303843 | 303842 | | | | 304115 | N/A | 304116 | |





RITESSCAPE™ MULTI-SIZE SCRAPERS REPLACEMENT PARTS

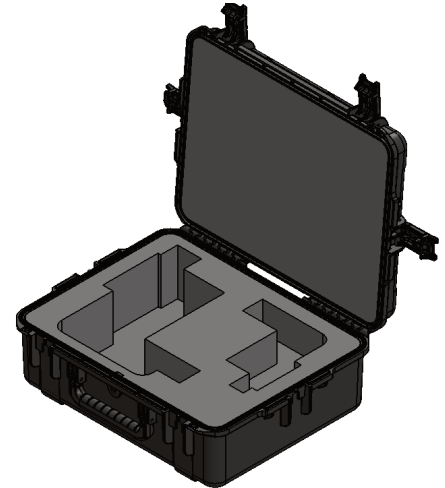
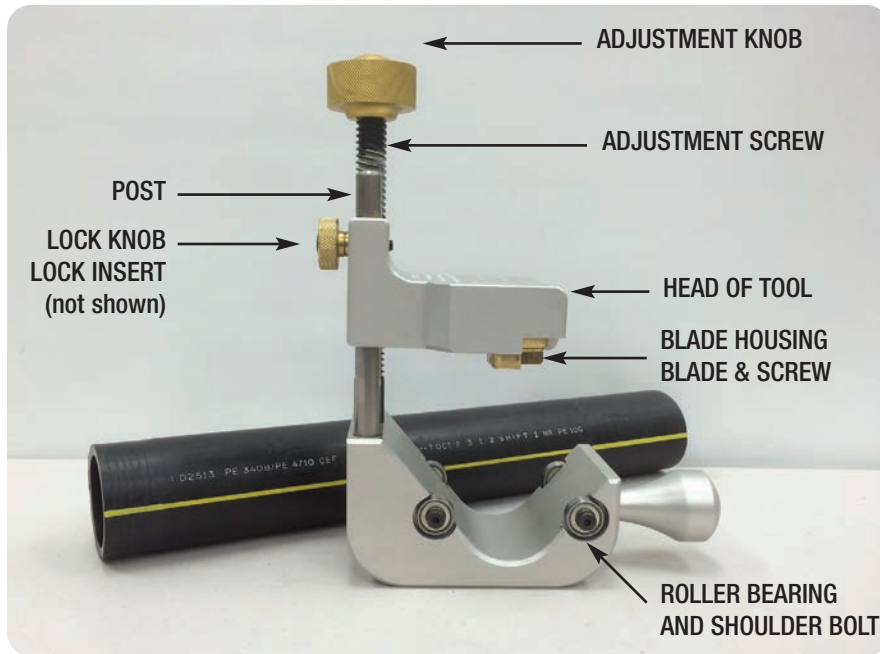

Carrying Case for
2" - 4" and 6" - 8" IPS

RIBBON READER ELECTROFUSION MEASURING GAUGE

- Stainless-Steel tool designed to measure the thickness of PE ribbon.
- Precisely slotted at measurements of .005"-.019" (odd numbers only).
- Size of a credit card to fit in a wallet.

| Product | Size Range | Part # |
|---------------|------------------------------|--------|
| Ribbon Reader | .005" - .019" (odd #'s only) | 310979 |



FUSEMASTER ELECTROFUSION MEASURING GAUGE

- Meets all standards requirements.
- Peel/ribbon thickness gauge, gouge, gap & out of roundness indicators, and pipe wall thickness chart - all in one tool.
- Pipe sizes from 1" to 12".

| Product | Size Range | Part # |
|----------|---------------|--------|
| FM16-19 | 1" - 6" Pipe | 305500 |
| FM212-19 | 2" - 12" Pipe | 305499 |





OLD STYLE ELECTROFUSION SCRAPERS

• Rotary Scrapers

| Model | Tubing/Pipe Size | Part # |
|--------------------------|------------------|--------|
| Old Style Rotary Scraper | 1-1/4" IPS | 303613 |
| | 2" IPS | 303547 |
| | 3" IPS | 303606 |
| | 4" IPS | 303587 |
| | 6" IPS | 309881 |
| | 8" IPS | 303731 |
| Insert Stiffener | 1-1/4 - 2" IPS | 303599 |

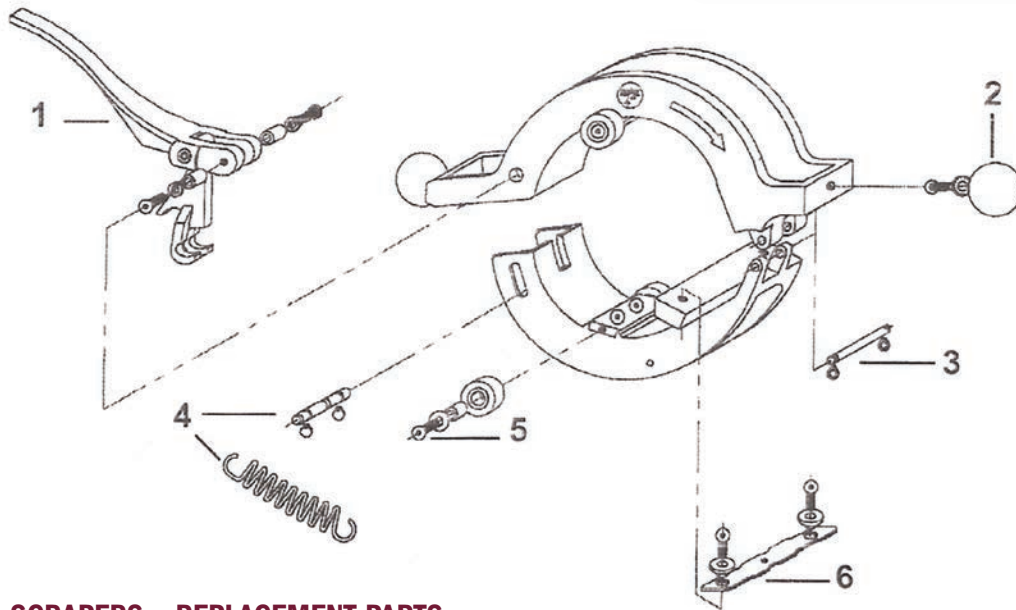

ELECTROFUSION SCRAPERS - REPLACEMENT PARTS

| Ref. No | Description | Pipe Size | Part # |
|---------|--------------------|---------------------|--------|
| 1 | Latch Assembly Kit | 1-1/4" IPS & 2" IPS | 303629 |
| | | 3" IPS & 4" IPS | 303734 |
| | | 6" IPS & 8" IPS | 303615 |
| 2 | Knob Assembly Kit | 1-1/4" IPS - 2" IPS | 310615 |
| | | 3" IPS - 8" IPS | 304485 |
| 3 | Main Hinge Kit | 1-1/4" IPS & 4" IPS | 308974 |
| | | 6" IPS & 8" IPS | 308975 |
| 4 | Spring Kit | 1-1/4" IPS & 2" IPS | 302903 |
| | | 3" IPS & 8" IPS | 303565 |

| Ref. No | Description | Pipe Size | Part # |
|---------|---------------------------|---------------------|--------|
| 5 | Wheel Kit | 1-1/4" IPS & 2" IPS | 303549 |
| | | 3" IPS & 4" IPS | 303544 |
| | | 6" IPS | 303545 |
| | | 8" IPS | 303546 |
| | | | |
| 6 | Spare Blades-Main Scraper | 1-1/4", 2" & 3" | 303602 |
| | | 4" | 303563 |
| | | 6", 8" | 303564 |





SEE PARTS LISTS

RITMO SCRAPER RTC 160

- Working range external: 2" IPS to 6" IPS.
- Mandrel device to cover all working diameters.
- Rotating arm with a blade supported.
- Designed to maintain consistent cutting depth.

| Model | Tubing/Pipe Size | Part # |
|-------------------|------------------|--------|
| RTC 160 | 2" - 6" IPS | 302064 |
| Replacement Blade | 2" - 6" IPS | 304000 |
| Carrying Case | For RTC 160 | 304192 |



SEE PARTS LISTS

RITMO SCRAPER RTC 315

- Working range external: 3" IPS to 12" IPS.
- Mandrel device to cover all working diameters.
- Rotating arm with a blade supported.
- Designed to maintain consistent cutting depth.

| Model | Tubing/Pipe Size | Part # |
|---------------|------------------|--------|
| RTC 315 | 3" - 12" IPS | 302065 |
| Carrying Case | For RTC 315 | 304192 |



ELSTER PERFECTION CHAMFER TOOL 2.0

- Provides consistent quality "bevel" to polyethylene pipe required to install Elster Perfection 2.0 Permasert Mechanical Coupling.

| Model | Tubing/Pipe Size | Part # |
|--------------------------------|------------------|--------|
| Elster Perfection Chamfer Tool | 1/2" CTS | 304543 |
| | 1/2" IPS | 304546 |
| | 3/4" CTS | 304547 |
| | 3/4" IPS | 304548 |
| | 1" CTS | 304544 |
| | 1" IPS | 304545 |
| | 1-1/4" CTS | 304549 |
| | 1-1/4" IPS | 304550 |
| | 1-1/2" IPS | 304551 |
| | 2" IPS | 304552 |





ALIGNRITE™ STANDARD ELECTROFUSION CLAMPS

- High quality billet aluminum construction
- Liners available for multiple size configurations

| Model | Tubing/Pipe Size | Part # |
|--|------------------|--------|
| ALIGNRITE Adjustable Clamp | 2" IPS | 304506 |
| Liner Set (NEW size now available) | 1-1/4" CTS | 310487 |
| Liner Set | 1-1/4" IPS | 304507 |
| Liner Set (NEW size now available) | 1" CTS | 310488 |
| Liner Set (NEW size now available) | 1" IPS | 310489 |
| | | |
| ALIGNRITE Adjustable Clamp | 8" IPS | 305799 |
| Liner Set | 6" IPS | 304592 |
| Liner Set (Requires 6" liner set for base) | 4" IPS | 305800 |
| | | |
| ALIGNRITE Straight Clamp | 4" | 304588 |
| Liner Set | 3" | 304591 |
| Liner Set (Requires 3" liner set for base) | 2" | 304590 |
| | | |
| ALIGNRITE Straight Clamp | 8" | 304589 |
| Liner Set | 6" | 304592 |
| Liner Set (Requires 6" liner set for base) | 4" | 304646 |
| | | |
| ALIGNRITE Hoop Style Straight Clamp | 12" | 304227 |



12" hoop style straight clamp

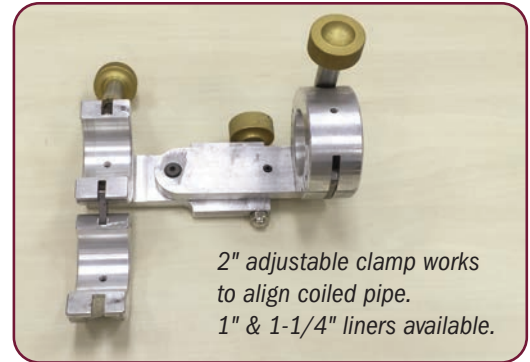

2" adjustable clamp works to align coiled pipe. 1" & 1-1/4" liners available.

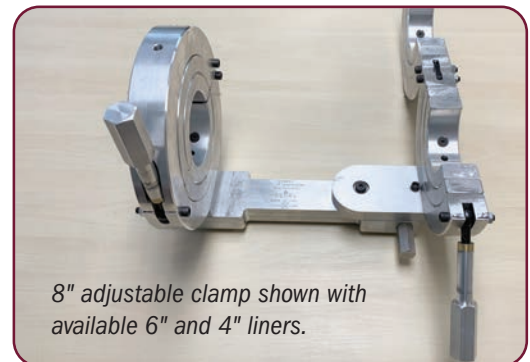

8" adjustable clamp shown with available 6" and 4" liners.



8" straight clamp. 4" & 6" liners available.

ALIGNRITE™ ARTICULATING ELECTROFUSION CLAMP

- Articulating arms with fixed positions at straight, 45° & 90°.
- 2" & 3" liners available.
- Adjustable mechanism for coiled pipe.

| Model | Tubing/Pipe Size | Part # |
|--|------------------|--------|
| ALIGNRITE Articulating Clamp | 4" | 305783 |
| Liner Set | 3" | 304591 |
| Liner Set (Requires 3" liner set for base) | 2" | 304590 |

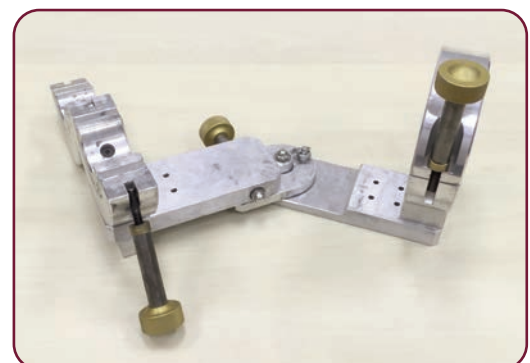



ALIGNRITE™ V-STYLE ELECTROFUSION CLAMP

- One tool for aligning 2"-6" or 6"-12" pipe.
- Quick release ratchet straps used to secure pipe.

| Model | Tubing/Pipe Size | Part # |
|-------------------------|------------------|--------|
| ALIGNRITE V-Style Clamp | 2" – 6" | 304638 |
| ALIGNRITE V-Style Clamp | 6" – 12" | 304195 |

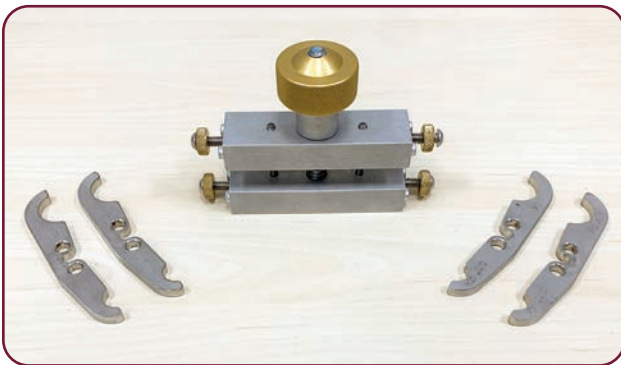

ALIGNRITE™ MINI ELECTROFUSION CLAMP

- Designed for 1/2" CTS through 1-1/4" IPS Tubing
- Purchased as Core Body only with various sized Dual-Sided Liners
- 3-in-1 design for size-on-size and Reducer Couplings (Choose 2 sizes)

| Model | Part # |
|---------------------------------------|--------|
| ALIGNRITE Mini Clamp – Core Body Only | 311051 |

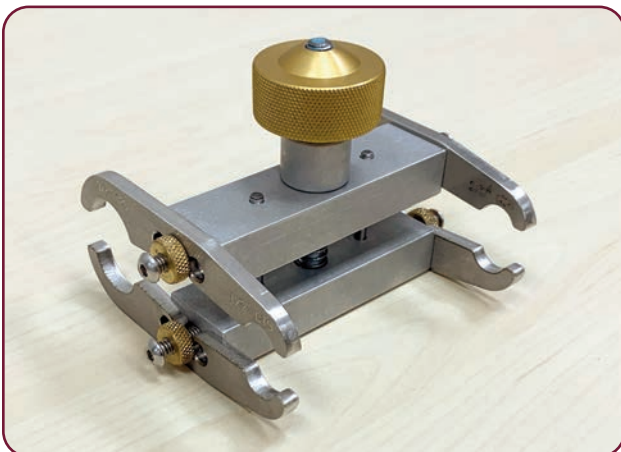

| Model | Tubing/Pipe Size | Part # |
|--|-------------------------|--------|
| ALIGNRITE Mini Clamp Dual-sided Liners | 3/4" IPS x 1/2" CTS | 311052 |
| | 1" CTS x 1/2" CTS | 311053 |
| | 1" CTS x 3/4" IPS | 311054 |
| | 1" IPS x 1/2" CTS | 311055 |
| | 1" IPS x 3/4" IPS | 311056 |
| | 1" IPS x 1" CTS | 311057 |
| | 1-1/4" IPS x 1/2" CTS | 311058 |
| | 1-1/4" CTS x 3/4" IPS | 311059 |
| | 1-1/4" IPS x 3/4" IPS | 311060 |
| | 1-1/4" CTS x 1" CTS | 311061 |
| | 1-1/4" CTS x 1" IPS | 311062 |
| | 1-1/4" IPS x 1" IPS | 311063 |
| | 1-1/4" IPS x 1" CTS | 311064 |
| | 1-1/4" IPS x 1-1/4" CTS | 311065 |



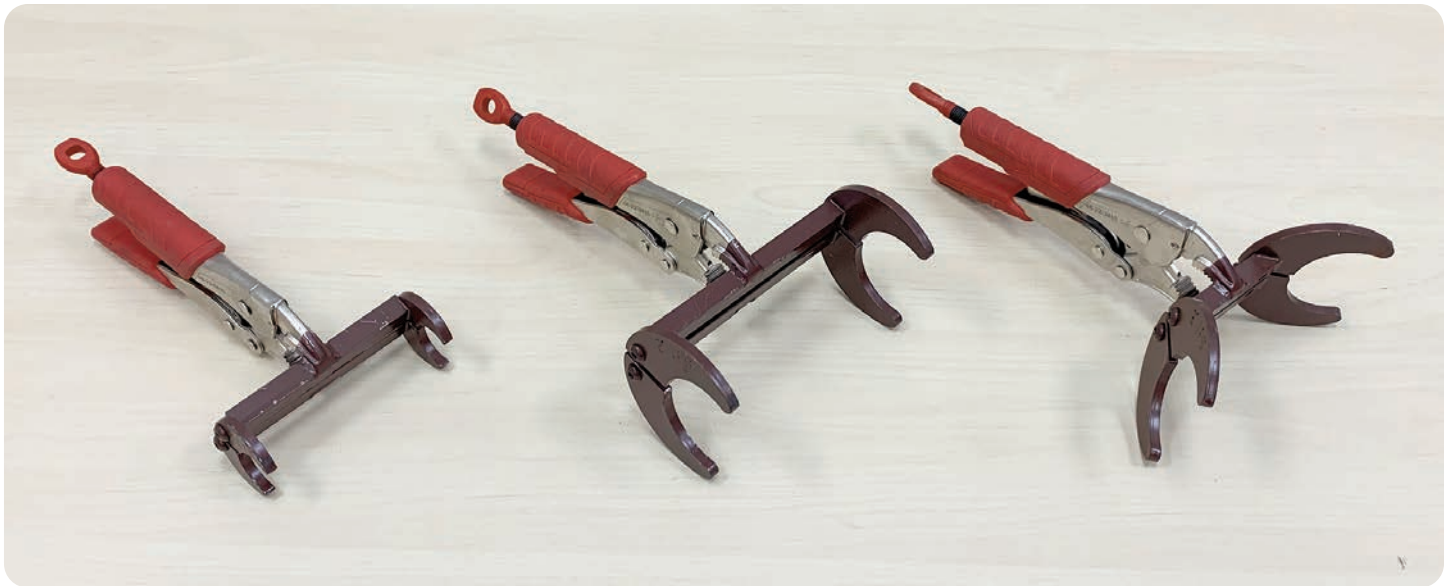

ALIGNRITE™ ELECTROFUSION TUBING CLAMPS

- Sizes 1/2" - 2" IPS available
- High-quality Milwaukee vise grips
- Sizes clearly etched on clamps
- Specialty sizes available by request

| Model | Tubing/Pipe Size | Part # |
|------------------------------|------------------|--------|
| ALIGNRITE Vise Grip Clamp | 1/2" CTS | 304135 |
| | 3/4" IPS | 304146 |
| | 1" CTS | 304155 |
| | 1" IPS | 304156 |
| | 1-1/4" CTS | 304139 |
| | 1-1/4" IPS | 304157 |
| | 1-1/2" IPS | 310551 |
| | 2" IPS | 304158 |

| Model | Tubing/Pipe Size | Part # |
|---|------------------|--------|
| ALIGNRITE 90° Elbow Vise Grip Clamp | 1/2" CTS 90° | 309631 |
| | 1" CTS 90° | 306369 |
| | 2" CTS 90° | 304230 |
| | 1-1/4" CTS 90° | 306808 |
| | 1-1/4" IPS 90° | 306822 |

| Model | Tubing/Pipe Size | Part # |
|------------------------------|-------------------------|--------|
| ALIGNRITE Vise Grip Clamp | 2" IPS x 1" CTS | 304160 |
| | 1-1/4" IPS x 1" IPS | 304153 |
| | 1-1/4" IPS x 1/2" CTS | 304151 |
| | 1-1/4" CTS x 1" IPS | 304152 |
| | 1-1/4" CTS x 1" CTS | 304161 |
| | 1" IPS x 1" CTS | 304159 |
| | 1" CTS x 1/2" CTS | 304144 |
| | 1" CTS x 3/4" IPS | 304142 |
| | 1" IPS x 3/4" IPS | 304143 |
| | 1" CTS x 3/4" CTS | 304145 |
| | 2" IPS x 1-1/4" IPS | 304147 |
| | 1/2" IPS x 1/2" CTS | 304148 |
| | 3/4" IPS x 1/2" IPS | 304149 |
| | 1-1/2" IPS x 1" CTS | 304154 |
| | 1-1/4" IPS x 1-1/4" CTS | 304150 |
| | 1-1/4" IPS x 1" CTS | 304136 |
| | 1" IPS x 1/2" CTS | 304137 |
| | 2" IPS x 1" IPS | 304138 |
| | 3/4" IPS x 3/4" CTS | 304140 |
| | 3/4" IPS x 1/2" CTS | 304141 |
| | 1-1/2" CTS x 1" IPS | 305587 |
| | 2" IPS x 1-1/2" IPS | 307730 |
| | 1-1/2" IPS x 1-1/4" IPS | 307731 |





Nutcracker



V-Tool



Adapter Jaws

JM EAGLE METFIT® INSTALLATION TOOL

- Effectively joins MetFit brand fittings.
- Nutcracker - dedicated 1/2" CTS tool.
- V-Tool - 1/2" CTS to 1-1/4" CTS with proper jaws.

| Model | Tubing/Pipe Size | Part # |
|------------------|-----------------------|--------|
| Nutcracker | 1/2" CTS | 304989 |
| V-Tool | 1/2" CTS - 1-1/4" CTS | 304889 |
| Adapter Jaws | 1/2" CTS | 302399 |
| Adapter Jaws | 1/2" IPS - 3/4" CTS | 302400 |
| Adapter Jaws | 3/4" IPS | 302401 |
| Adapter Jaws | 1" CTS | 302402 |
| Adapter Jaws | 1" IPS - 1-1/4" CTS | 302403 |
| Replacement Pins | Set of 2 | 302406 |

JM EAGLE METFIT® SERIES 200 HYDRAULIC SYSTEM



| Model | Tubing/Pipe Size | Part # |
|---------------------------|---|--------|
| Series 200 Tool (no pump) | Includes 2" liners | 305229 |
| Series 200 System | Includes tool, pump, hose, 2" IPS liners only | 303821 |
| Series 200 System | Includes tool, pump, hose, 1-1/4" IPS and 2" IPS liners | 303279 |
| Adapter Jaws | 2" IPS | 302405 |
| Adapter Jaws | 1-1/4" IPS | 302404 |
| Adapter Jaws | 1-1/2" IPS | 303866 |
| Relief Valve | For Series 200 | 303805 |
| Hydraulic Pump | Dual Stage | 303335 |
| Hydraulic Hose | For Series 200 | 304597 |
| Hydraulic Pump Oil | For Series 200 | 304214 |



Ask your representative about our tool repair services



LYALL LYCOFIT® QUICK RATCHET PRESS

- **Quick Ratchet Press (QRP-125)** – lightweight, durable, single ratchet field assembly tools that install all LYCOFIT® couplings from 1/2" CTS through 1-1/4" CTS.
- **Dual Quick Ratchet Press (QRP-200)** – Designed for manual installations, the dual ratchet design makes it simple to install on medium to large sized piping systems. Installs all LYCOFIT® couplings from 1/2" CTS through 2" IPS.

| Model | Tubing/Pipe Size | Part # |
|----------|-----------------------|--------|
| QRP-125* | 1/2" CTS – 1-1/4" CTS | 302907 |
| QRP-200* | 1/2" CTS – 2" IPS | 302908 |

*Ratchets not included



QRP-125



QRP-200

LYALL LYCO® HYDRAULIC PRESS

- **LycO Hydraulic Press (LHP-200)** – The LycO Hydraulic Press (LHP -200) is used for joining 1-1/4" IPS, 1-1/2" IPS, and 2" IPS sizes of medium or high density polyethylene gas pipe, utilizing LYCOFIT® Mechanical Fittings. This hydraulic tool is capable of installing standard couplings, end-caps, 90° elbows, 3-way tees, repair couplings, and many combinations of reducing fittings.

| Model | Description | Part # |
|----------------|---|--------|
| LHP-200-KIT-01 | Hydraulic Press w/ P-142 Hand Pump, Hose, Clamps, and Carrying Case | 304127 |
| AHP200 | Enerpac P-142 Hand Pump with fittings for LHP200 | 305912 |

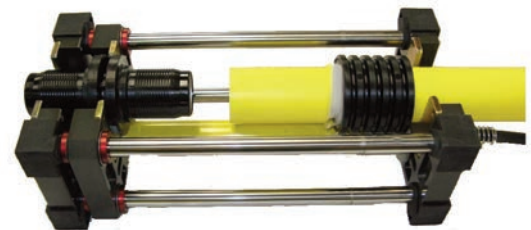

LHP-200



AHP-142





ESSENTRA® ALCOHOL WIPES

- Pre-saturated wipes.
- Free of additives.
- Very low levels of sodium and other ions.
- Class 100/10 compatible wipe.
- Resealable container reduces contaminant exposure.

| Model | Quantity / Size | Part # |
|---------------|-----------------------|--------|
| Packets (box) | 60 (6" x 8.5" sheet) | 304721 |
| Canister | 100 (6" x 8.5" sheet) | 304722 |



EDL E-Z PROBE COMPACT PYROMETER

- Compact, durable pyrometer that can be calibrated.
- Input jacks at top & bottom give operator complete versatility.
- Magnetic backing for hands-free use.
- Factory calibration available.

| Model | Description | Part # |
|------------------------|--|--------|
| EZK-C Kit | Includes EZK-C, Straight Surface Sensor & Case | 306920 |
| EZK-C Kit (Calibrated) | Includes EZK-C, Straight Surface Sensor & Case | 306919 |
| E-Z Probe EZK-C | -30° - 1800° F | 303396 |
| Surface Sensor | Straight | 303427 |
| Hard Carrying Case | With Foam Insert | 306862 |



Plastic Pipe Squeeze & Cutting Tools

Our inside and outside sales representatives have the knowledge and experience to make sure you have the right tool for the right job.

SQUEEZE-OFF TOOLS
GROUNDING RODS
TOPSIDE CLAMPS
TOP REACH CLAMPS
SHEARS
CUTTERS



MUSTANG GLS 26

- Top-side operation for keyhole applications.
- Mid-range squeeze tool.
- Direct dial squeeze control.
- Heavy duty frame.
- Includes grounding rod.

| Model | Tubing/Pipe Size | Part # |
|--------|-------------------|--------|
| GLS 26 | 1/2" CTS - 2" IPS | 304032 |



MUSTANG DBS 10A

- Service size squeeze tool.
- Single size specific.
- Open frame design.

| Model | Tubing/Pipe Size | Part # |
|--|-------------------|-------------|
| DBS 10A | 1/2" CTS - 1" IPS | Please call |
| Customer Must Specify One Pipe Size and SDR Per Unit | | |



MUSTANG DBS 20C

- Mid-range squeeze tool.
- Accommodates two pipe sizes.
- Heavy duty frame.

| Model | Tubing/Pipe Size | Part # |
|---|-------------------|-------------|
| DBS 20C | 1/2" CTS - 2" IPS | Please call |
| Customer Must Specify Two Pipe Sizes and SDR's Per Unit | | |



Ask your representative about our tool repair services



MUSTANG DBS 24C

- Mid-range squeeze tool.
- Accommodates four pipe sizes.
- Heavy duty frame.

| Model | Tubing/Pipe Size | Part # |
|--|-------------------|-------------|
| DBS 24C | 1/2" CTS - 2" IPS | Please call |
| Customer Must Specify Four Pipe Sizes and SDR's Per Unit | | |



MUSTANG DBS 44F

- Mid-range squeeze tool.
- Accommodates four pipe sizes.
- Heavy duty frame.

| Model | Tubing/Pipe Size | Part # |
|--|------------------|-------------|
| DBS 44F | 1" – 4" IPS | Please Call |
| Customer Must Specify Four Pipe Sizes and SDR's Per Unit | | |



MUSTANG DBG 60

- Mid-duty squeeze tool.
- Accommodates two pipe sizes.
- Heavy-duty frame.
- Includes SC-60 saddle clamps. (see page 24)

| Model | Tubing/Pipe Size | Part # |
|---|------------------|-------------|
| DBG 60 | 3" – 6" IPS | Please Call |
| Customer Must Specify Two Pipe Sizes and SDR's Per Unit | | |



Ask your representative about our tool repair services





MUSTANG HYDRAULIC DBM 60

- Mid-duty squeeze tool.
- Accommodates two pipe sizes.
- Heavy-duty frame.
- Includes 20A Pump and SC-60 saddle clamps.

| Model | Tubing/Pipe Size | Part # |
|---|------------------|-------------|
| DBM 60 | 3" – 6" IPS | Please Call |
| Customer Must Specify Two Pipe Sizes and SDR's Per Unit | | |



MUSTANG HYDRAULIC DBML 80

- Mid-duty squeeze tool.
- Accommodates two pipe sizes.
- Heavy-duty frame.
- Includes 20A Pump and SC-80 saddle clamps.

| Model | Tubing/Pipe Size | Part # |
|---|------------------|-------------|
| DBML 80 | 3" – 8" IPS | Please Call |
| Customer Must Specify Two Pipe Sizes and SDR's Per Unit | | |



MUSTANG HYDRAULIC DBH 1200B

- Heavy-duty squeeze tool.
- Accommodates four pipe sizes.
- Heavy-duty frame.
- Includes 25A Pump and SC-1200 saddle clamps.

| Model | Tubing/Pipe Size | Part # |
|--|------------------|-------------|
| DBH 1200B | 6" – 12" IPS | Please Call |
| Customer Must Specify Four Pipe Sizes and SDR's Per Unit | | |



Ask your representative about our tool repair services

Call now to place an order
973-335-4800



MULCARE





MUSTANG GROUNDING ROD

- Attaches to upper jaw grease fitting.
- Insulated braided copper cable and cast copper spike.

| Model | Size | Part # |
|--------|---------------------|--------|
| SEG 30 | 5' Cable, 12" Spike | 304033 |

Grounding rods are recommended for use during all squeeze operations.



MUSTANG SADDLE CLAMPS

- Use with large pipe squeeze tools when additional compressive force is needed for difficult to squeeze PE pipe.
- SC-60 & SC-80 available in yellow (hydraulic) or blue (manual).

| Model | Tubing/Pipe Size | Part # |
|----------|---|-------------|
| SC-40/44 | Fits Series 40/44 Squeeze tools | 309096 |
| SC-60 | Fits Series 60 Squeeze tools | Please Call |
| SC-80 | Fits Series 80 Squeeze tools (Yellow - Hydraulic) | 304188 |
| SC-80 | Fits Series 80 Squeeze tools (Blue - Manual) | 304189 |



MUSTANG HYDRAULIC PUMPS

- 2 stage design for rapid movement of upper jaw.
- High capacity oil reservoir and built-in pressure relief valve.

| Model | For use with | Part # |
|-----------------|------------------------------|--------|
| 25A (with hose) | H Series Tools | 310620 |
| Model 30 | DBM 60 & DBML 80 | 307831 |
| Hydraulic Oil | Use with all hydraulic tools | 304214 |



Ask your representative about our tool repair services





Rotating sleeve gives you 3 sizes in one tool.



TC-1

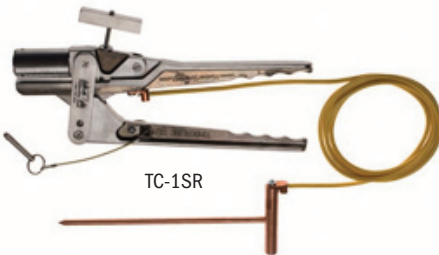

TC-1SR

Grounding rod and locking pin sold separately

TC-1 / TC-1SR / TC-2 TOPSIDE CLAMPS

- Rotating sleeve adjusts for multiple pipe sizes.
- Extension handles available. Custom lengths available.
- Customer must select multiple pipe sizes per unit.

| Model/Part | Tubing/Pipe Size | Part # |
|-----------------------|------------------------|-------------|
| TC-1 | 1/2" CTS - 1-1/4" CTS | Please Call |
| TC-1SR (slow release) | 1/2" CTS - 1-1/4" CTS | Please Call |
| TC-2 | 1/2" CTS - 2" IPS | Please Call |
| Grounding rod | With solid copper wire | 303297 |
| Locking Pin | NA | 302910 |
| Case | TC-1 + Grounding Rod | 303941 |



TR270



TR650

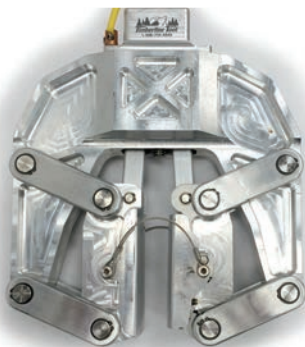

TR170 TOP REACH CLAMP

Top-down remote squeeze-off solution for 1/2" - 1-1/4" CTS.

- Length: 6.5' / Width: 6.0" / Weight: 23.0 lb.
- Standard Equipment:
 - Grounding rod with 10' copper cable.
- Customer must select 3 pipe sizes per unit.

TR270 TOP REACH CLAMP

Top-down remote squeeze-off solution for 1/2" CTS - 2" IPS.

- Length: 6.5' / Width: 10.5" / Weight: 19.0 lb.
- Standard Equipment:
 - 4 slap-on jaws specific to customer pipe sizes.
 - Hard carrying case.
 - Grounding rod with 10' copper cable.
- Customer must select 4 pipe sizes per unit.

TR650 TOP REACH CLAMP

Top-down remote squeeze-off solution for 3" - 6" IPS.

- Length: 6.5' / Width: 17.8" / Weight: 116 lbs.
- Standard Equipment:
 - Hard carrying case.
 - Grounding rod with 10' copper cable.
- Customer must select 2 pipe sizes per unit.

| Model | Tubing/Pipe Size | Part # |
|-------|-----------------------|-------------|
| TR170 | 1/2" CTS - 1-1/4" CTS | Please Call |
| TR270 | 1/2" CTS - 2" IPS | Please Call |
| TR650 | 3" IPS - 6" IPS | Please Call |



REED RATCHET SHEARS

| Model | Tubing/Pipe Size | Part # |
|--------|------------------------------------|--------|
| RS1 | Cuts through 1-1/4" CTS | 302374 |
| RS1PLT | RS1 with Corrosion Resistant Blade | 302376 |
| RS2 | Cuts through 2" | 302377 |
| RS7290 | Cuts 2" PE Pipe and PVC | 303160 |

| Model | Description | Part # |
|---------|----------------------------------|--------|
| RS1B | RS1 Blade | 302375 |
| RS1BPLT | RS1PLT Plated Blade | 309626 |
| RS2B | RS2 Blade | 302378 |
| RS7290B | RS7290 Blade (fits Wheeler 7290) | 306797 |
| All | PEGRM Static Grounding Device | 307248 |



REED IN-LINE ROTARY CUTTER

- Creates no dust and chips fall where they are cut.
- Only 6"-8" clearance needed to turn PLAS around pipe.

| Model | Tubing/Pipe Size | Part # |
|---------|-------------------------------|--------|
| PLAS1PE | Cuts through 6" - 12" PE Pipe | 304095 |
| PLASPEB | Replacement Blade | 304108 |



REED GUILLOTINE CUTTERS

| Model | Tubing/Pipe Size | Part # |
|-------|------------------|--------|
| HPC4+ | 2" - 4" | 307954 |
| HPC8+ | 3" - 8" | 306396 |
| HPC12 | 4" - 12" | 302370 |

| Model | Description | Part # |
|--------|--------------------|--------|
| HPC4B | HPC4 / HPC4+ Blade | 302372 |
| HPC8B | HPC8 / HPC8+ Blade | 302373 |
| HPC12B | HPC12 Blade | 302543 |



NEW
2"-4" & 3"-8"
all aluminum
body. 22%
lighter!



SEE PARTS LISTS



Ask your representative about our tool repair services





*PERC Electrofusion Processors
being assembled here in the U.S.*

Located on Page 5

Gas Main Tapping

Safe, gas-free tapping of plastic main is essential in today's gas industry. Mulcare not only offers the tools, but can also provide training and field support to make sure your crew is comfortable with the latest technology.

**NUPI HOT TAP SYSTEM
SKINNER DRILLING DEVICES**





Hot Tap System



NUPI CLOSE QUARTERS HOT TAP SYSTEM

- Effectively taps 2" - 8" laterals on PE main up to 12".
- Same assembly can be used for camera fittings.
- Gas free to 120 psi (no-blow).
- Fastens directly to valve, no extra fusions needed.
- Ultra compact design.

| Model | Pipe Size | Part # |
|----------------|----------------|--------|
| Hot Tap System | 2" - 12" Mains | 302028 |

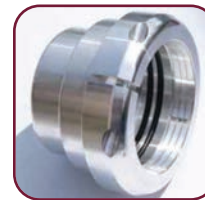

| Model / Size | Part # |
|-------------------|--------|
| Bell Adapter - 2" | 304072 |
| Bell Adapter - 3" | 310625 |
| Bell Adapter - 4" | 304073 |
| Bell Adapter - 6" | 304074 |
| Bell Adapter - 8" | 304358 |



| Model / Size | Part # |
|--------------|--------|
| Cutter - 2" | 304075 |
| Cutter - 3" | 304359 |
| Cutter - 4" | 304076 |
| Cutter - 6" | 304077 |
| Cutter - 8" | 304360 |



Branch Saddle Assembly Set-up



Camera Fitting Set-up



Camera Fitting Kit
302032



Pressure Gauge
301938



SKINNER DRILLING DEVICES (NOT FOR USE ON LIVE GAS TAPS)

METHOD A – STREET TEE IN SERVICE SADDLE

| Top Thread of Tee (inches) | 3/4 | | 1 | | 1-1/4 | | 1-1/2 | | 2 | |
|---|-----|------------|-----|------------|-------|------------|-------|------------|-----|------------|
| Drill Device No. | 4 | | 7 | | 7 | | 7 | | 7 | |
| Adapter No. | 1 | | 2 | | 3 | | 4 | | 5 | |
| Stock cutter numbers and diameters that can be used under this method | No. | Dia. (in.) | No. | Dia. (in.) | No. | Dia. (in.) | No. | Dia. (in.) | No. | Dia. (in.) |
| | 1 | 5/8 | 22 | 7/8 | 7 | 1 | 19 | 1-3/16 | 21 | 1-7/8 |
| | 2 | 1/2 | 11 | 3/4 | 22 | 7/8 | 7 | 1 | 20 | 1-3/8 |
| | 3 | 3/8 | 2 | 1/2 | 2 | 1/2 | 11 | 3/4 | 19 | 1-1/5 |
| | 4 | 1/4 | 4 | 1/4 | 4 | 1/4 | 2 | 1/2 | 7 | 1 |



SKINNER DRILLING DEVICES: METHOD B – SERVICE SADDLE WITHOUT STREET TEE

| Top Thread of Tee (inches) | 3/4 | | 1 | | 1-1/4 | | 1-1/2 | | 2 | |
|---|-----|------------|-----|------------|-------|------------|-------|------------|-----|------------|
| Drill Device No. | 4 | | 7 | | 7 | | 7 | | 7 | |
| Adapter No. | 14 | | 15 | | 16 | | 23 | | 24 | |
| Stock cutter numbers and diameters that can be used under this method | No. | Dia. (in.) | No. | Dia. (in.) | No. | Dia. (in.) | No. | Dia. (in.) | No. | Dia. (in.) |
| | 11 | 3/4 | 7 | 1 | 19 | 1-3/16 | 20 | 1-3/8 | 21 | 1-7/8 |
| | 1 | 5/8 | 11 | 3/4 | 7 | 1 | 19 | 1-3/16 | 20 | 1-3/8 |
| | 2 | 1/2 | 2 | 1/2 | 11 | 3/4 | 7 | 1 | 19 | 1-3/16 |
| | 4 | 1/4 | 4 | 1/4 | 2 | 1/2 | 11 | 3/4 | 7 | 1 |



SKINNER DRILLING DEVICES: METHOD C – TEE OR PIPE NIPPLE WELDED TO MAIN

| Top Thread of Tee (inches) | 3/4 | | 1 | | 1-1/4 | | 1-1/2 | | 2 | |
|---|-----|------------|-----|------------|-------|------------|-------|------------|-----|------------|
| Drill Device No. | 4 | | 7 | | 7 | | 7 | | 7 | |
| Adapter No. | 6 | | 7 | | 8 | | 9 | | 10 | |
| Stock cutter numbers and diameters that can be used under this method | No. | Dia. (in.) | No. | Dia. (in.) | No. | Dia. (in.) | No. | Dia. (in.) | No. | Dia. (in.) |
| | 11 | 3/4 | 7 | 1 | 19 | 1-3/16 | 20 | 1-3/8 | 21 | 1-7/8 |
| | 1 | 5/8 | 11 | 3/4 | 7 | 1 | 7 | 1 | 19 | 1-3/16 |
| | 2 | 1/2 | 2 | 1/2 | 11 | 3/4 | 11 | 3/4 | 7 | 1 |
| | 4 | 1/4 | 4 | 1/4 | 2 | 1/2 | 2 | 1/2 | 11 | 3/4 |



SKINNER DRILLING DEVICES: METHOD D – VALVE CONNECTED TO MAIN

| Top Thread of Tee (inches) | 1 | | 1-1/4 | | 1-1/2 | | 2 | |
|---|-----|------------|-------|------------|-------|------------|-----|------------|
| Drill Device No. | 10 | | 10 | | 10 | | 10 | |
| Adapter No. | 27 | | 26 | | 25 | | 22 | |
| Stock cutter numbers and diameters that can be used under this method | No. | Dia. (in.) | No. | Dia. (in.) | No. | Dia. (in.) | No. | Dia. (in.) |
| | 7 | 1 | 19 | 1-3/16 | 20 | 1-3/8 | 21 | 1-7/8 |
| | 11 | 3/4 | 7 | 1 | 19 | 1-3/16 | 20 | 1-3/8 |
| | 2 | 1/2 | 11 | 3/4 | 7 | 1 | 19 | 1-3/16 |
| | 4 | 1/4 | 2 | 1/2 | 11 | 3/4 | 7 | 1 |

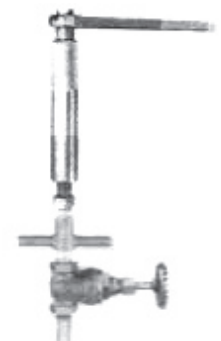

Please contact us for help in ordering the correct equipment for your application.





An odorization set-up on a live gas main. The main was tapped utilizing the NUPI 8x2 Camera Fitting and NUPI Close Quarters Hot Tap System.

Look for the Nupi Close Quarters Hot Tap System on Page 29

Service Renewal

Reamer kits effectively remove scale, slag, and weld beads from old steel services making the insertion of plastic much safer and easier.

REAMER KIT
CURB VALVE DRILL KIT
NOSE CONES









MULCARE GAS LINE REAMER KIT

- Smart, efficient way to clean a gas line prior to the insertion of polyethylene tubing.
- A powerful drilling and chipping action thoroughly removes any deposits in the steel gas line.
- Kit includes everything needed to thoroughly clean a gas line, including a tool box to hold all the components.
- For heavily obstructed gas lines, we recommend the special spherical “Cherry Burr” cleaning head.





PARTS

(included in each kit)

| Existing Pipe Size | Complete Kit |  |  |  |  |  | See picture above | |
|---------------------|--------------|---|---|---|--|---|-------------------|----------|
| | | Qty 1 | Qty 1 | Qty 1 | Qty 3 | Qty 12 | Qty 1 | Qty 1 |
| | Part # | Air Motor | Universal Joint | Single-Pin Head | Cone Cutter | Star Cutter | Wrench | Tool Box |
| | Part # | Part # | Part # | Part # | Part # | Part # | Part # | Part # |
| 3/4" IPS (19.1mm) | 302253 | 302251 | 302256 | 302255 | 302252 | 302254 | 302257 | 310627 |
| 1" IPS (25.4mm) | 302259 | 302258 | 302261 | 302260 | 309651 | 309652 | 309653 | |
| 1-1/4" IPS (31.8mm) | 302264 | 302262 | 302267 | 302266 | 302263 | 302265 | 302268 | |
| 1-1/2" IPS (38.1mm) | 302270 | 310626 | | 302272 | 302269 | 302271 | 309654 | |

ACCESSORIES

(not included)

| Existing Pipe Size |  |  |  |  |  |
|---------------------|---|---|--|---|---|
| | 50 ft Air Hose | Air Line Lubricator | Wilsolube Lubricant | Flexible Holder | Cherry Burr |
| | Part # | Part # | Part # | Part # | Part # |
| 3/4" IPS (19.1mm) | 302243 | 302247 | 302250 | 302273 | 302274 |
| 1" IPS (25.4mm) | 302245 | 302248 | | 309655 | 309656 |
| 1-1/4" IPS (31.8mm) | | | | 302275 | 302276 |
| 1-1/2" IPS (38.1mm) | 302246 | 302249 | | N/A | N/A |
| 2" IPS (50.8mm) | | | | N/A | N/A |

MULCARE X-PANDER NOSE CONES

- X-Pander nose cones make plastic insertion smooth and easy.
- Prevents damage to your plastic insert.



| Pipe Size | Part # |
|-----------|--------|
| 1/2" IPS | 302356 |
| 1/2" CTS | 302357 |
| 3/4" IPS | 302358 |
| 1" IPS | 302359 |
| 1" CTS | 302360 |

| Pipe Size | Part # |
|------------|--------|
| 1-1/4" IPS | 302361 |
| 1-1/4" CTS | 303243 |
| 1-1/5" IPS | 302362 |
| 2" IPS | 302363 |

Call now to place an order
973-335-4800



WILSON CURB VALVE DRILL KIT

- Designed for drilling through valves and other obstructions in a gas line so a replacement line can be inserted inside the old line.
- Kit includes hole saws for 3/4", 1", 1-1/4", 1-1/2" and 2" gas lines.
- The Curb Valve Drill Kit includes all the tools and components needed to quickly and efficiently drill through valves and other gas line obstructions.
- Includes a tool box to hold all the components.
- One and two-foot extension rods are easily assembled, enabling the tool to reach over 50 feet into a gas line.



| Model | Quantity | Part # |
|------------------------|----------|--------|
| Full Kit | 1 | 302236 |
| Air Motor | 1 | 303989 |
| Hole Saw 3/4" | 1 | 302232 |
| Hole Saw 1-1/4" | 1 | 302233 |
| Hole Saw 1-1/2" | 1 | 302234 |
| Hole Saw 2" | 1 | 306124 |
| Carrying Case | 1 | 310628 |
| Drive Shank 1 ft | 1 | 302230 |
| Drive Shank 2 ft | 1 | 302231 |
| Saw Adapter (1/2 - 20) | 2 | 302241 |
| Saw Adapter (5/8 - 18) | 2 | 302239 |
| Rod Assembly 1 ft | 2 | 302238 |
| Rod Assembly 2 ft | 25 | 302240 |
| Rod Adapter | 15 | 302237 |
| Dead Handle | 1 | 302229 |
| Jacobs Chuck 1/2" | 1 | 310629 |
| Jacobs Chuck Key | 1 | 302235 |





*Kleiss stop off system being used
on a live main.*

Located on Page 41

A valve maintenance program is critical to maintaining a safe gas distribution system.

Having the right tools for the right job saves time and promotes a safe working environment.

Our wide selection of pipe tools can be set up to tackle almost any job.

VALVE GATE KEYS
VALVE EXTENSIONS
CLEANOUT TOOLS
HYPREGUN
PLUG VALVE SEALANT
SEALANT INJECTION RODS
PIPE WRENCH ASSIST



REED VALVE GATE KEYS

- Compact size.
- Wide choice of attachable tools.
- Several socket configurations.

| Model | Length | Part # |
|--------------------|--------|--------|
| Main Valve Key | 6' 8" | 304045 |
| Main Valve Key Kit | 12' 7" | 310624 |

Length represents the key as sold without any extra pieces



KRAVITCH VALVE GATE KEYS

- Various lengths available.
- Offered in different shank materials.
- Several socket configurations.

| Model | Size | Part # |
|------------------------------|-----------|-------------|
| Long Eye Operator Gate Key | 3' – 6' | Please Call |
| Fixed Open Gate Valve Socket | 1/2" – 2" | Please Call |



KRAVITCH CLEANOUT TOOLS

- Various styles and lengths available.
- Remove stones, dirt and debris from curb and valve boxes.

| Model | Part # |
|---------------------------|-------------|
| Valve Spoon | Please Call |
| Duckbill Cleanout (CT106) | Please Call |
| Clamshell (Small CT110) | Please Call |
| Clamshell (Large CT109) | Please Call |



FLOWERVE NORDSTROM HYPREGUN

- Compact and efficient design.
- Air operated sealant injection with 15,000 psi gauge.
- Versatile design for servicing small or large valves.
- Motors operate at 100:1 pressure on 100 to 125 psi air.
- Ten foot hose is easily extended into tight spaces.

| Model | Size | Part # |
|---------------------|----------|--------|
| Hypregun-Plus 5G | 5 Gallon | 303622 |
| Hypregun 5Q | 5 Quart | 302905 |
| Valve Purge | 5 Quart | 302396 |
| Button Head Coupler | — | 303272 |



FLOWERVE NORDSTROM 400-D HAND GUN

- Versatile hand-held operation.
- Perfect for tight quarters or remote locations.
- Rated at 10,000 to 11,000 psi.
- Dependable performance under all conditions.

| Model | Part # |
|------------------------|--------|
| 400-D Hand Gun | 302387 |
| Case | 310116 |
| Valve Purge - Gun Pack | 302397 |
| Button Head Coupler | 303272 |



PLUG VALVE SEALANT

| Sealant | Size A | Size B | Size C | Size D | Size G | Size J | Size K | Gun Pak | Cartridge | 5 Quart | 5 Gallon |
|----------|--------|--------|--------|--------|--------|--------|--------|---------|-----------|---------|----------|
| Quantity | 24 | 24 | 24 | 24 | 24 | 6 | 12 | 6 | 4 | 1 | 1 |
| Diameter | .25 | .41 | .55 | .66 | .86 | 1.47 | 1.53 | — | — | — | — |
| Length | .88 | 1.38 | 2 | 2.44 | 3.38 | 8.75 | 10 | — | — | — | — |

Please call to order for your specific application.

SEALANT COMPOSITION

| Sealant | 167 | 234 | 421 | 555 | 654 | 755 | 950 | 960 | 1033 |
|----------|-------------|----------|-------------|---------------|-------------|-------------|-----------|-----------|-----------|
| Color | Gray | White | Cream | Brown | Brown | Pink | Cream | Cream | Green |
| Base Oil | Hydrocarbon | Silicone | Hydrocarbon | Vegetable Oil | Hydrocarbon | Polyglycols | Synthetic | Synthetic | Synthetic |



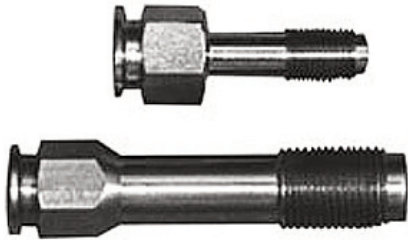

SEALANT INJECTION RODS & FITTINGS

- Sizes 3' – 8'.
- All fittings rated at 10,000 psi or above.
- Available in painted or stainless steel.
- Please call for pricing.

| Model | Size | Part # |
|---------------------------|-------------|--------|
| Button Head Fitting | 1/4" | 304733 |
| Button Head Fitting | 3/8" | 304730 |
| Button Head Fitting | 1/2" | 304731 |
| Button Head Fitting | 3/4" | 304732 |
| Giant Button Head Fitting | 1/4"-18 NPT | 304734 |

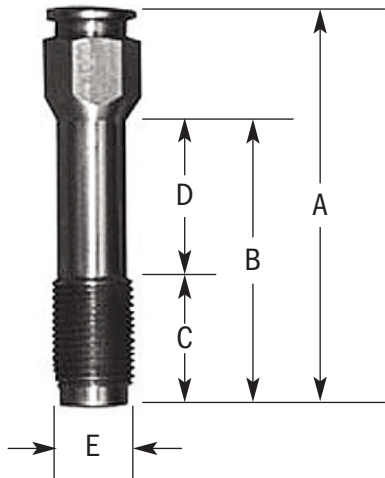

FITTING CHART

| | A | B | C | D | E |
|------|-------|------|-------|------|------|
| 1/4" | 2.36" | 1.5" | 1.25" | .25" | .52" |
| 3/8" | 3.06" | 2.0" | 1.8" | .20" | .65" |
| 1/2" | 3.3" | 2.7" | 2.1" | .60" | .81" |
| 3/4" | 4.68" | 3.5" | 1.7" | 1.8" | 1" |

PIPE WRENCH ASSIST

- Cast Aluminum designed to gradually yield before equipment is over-torqued
- Tool is secured to the wrench by a Safety D-Ring which prevents rotating or detaching
- Available in padded or knurled anti-slip handle

| Wrench Size | Padded Part # | Knurled Part # |
|-------------|---------------|----------------|
| 14" | 305724 | 305725 |
| 18" | 305197 | 305726 |
| 24" | 305198 | 305257 |
| 36" | 310621 | 305727 |
| 48" | 310622 | 310623 |



Call now to place an order
973-335-4800

Flow Stop Off, Bags & Plugs

Mulcare stocks a large array of plugs, bags and stoppers. Our staff is well-versed in making sure you have the right stopper for your application.

Ask about our stop off system for cast iron, steel and plastic for up to 60psi

MCS KLEISS FLOW STOP SYSTEM

WOOD PLUGS

SERVISTOPS

X-PANDER PLUGS

EXPANSION PLUGS

SAFETY MAIN STOPPER BAGS

GOODMAN STOPPERS



MCS KLEISS FLOW STOP SYSTEM

- Lightweight, easy-to-handle and install.
- Designed for all pipe materials – cast iron, steel, polyethylene, and PVC.
- Use with a range of pipe sizes.
- Only one size drilling cutter needed for all pipe sizes.
 - 3" - 8" System – 2" Cutter (Up to 60 psi)
 - 10" - 16" System – 4" Cutter (Up to 60 psi)
 - 18" - 24" System – 6" Cutter (Up to 15 psi)
- Single tap with one tool provides multiple functions.
 - System line pressure monitoring.
 - Downstream pressure monitoring.
 - MDS Stopper inflation and monitoring.
 - Pipeline purging/evacuating and venting.
- Patented MDS Stopper.
- 3X safety factor with a gas tight seal.

| Model | Tubing/Pipe Size | Part # |
|--------------|---|-------------|
| MCS60-38 | 3" - 8" | Please Call |
| MCS60-1016 | 10" - 16" | Please Call |
| MCS15-1824 | 18" - 24" | Please Call |
| Drilling Kit | 3" - 8" | Please Call |
| Drilling Kit | 10" - 16" | Please Call |
| Drilling Kit | 18" - 24" | Please Call |
| Jack System | For MCS60-38 | 305681 |
| Jack System | For MCS60-1016 & MCS15-1824 (requires Jack Bracket) | 305682 |
| Jack Bracket | For MCS60-1016 & MCS15-1824 | 305683 |
| MCS6038ESPK | Spare Parts Kit | 309188 |



Flow Stopping System



Drilling Kit



Ask your representative about our inspection and preventative maintenance programs

Call now to place an order
973-335-4800

MULCARE



X-PANDER PIPELINE SAFETY PLUGS

- Use to shut off gas flow for testing, service or even to keep dirt out of pipes during installation.
- Plug sizes 3/4" – 2".
- Wrench sizes 7" – 48" long.
- Custom sizes available.
- Can be used over and over.

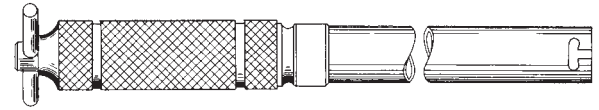

WRENCH

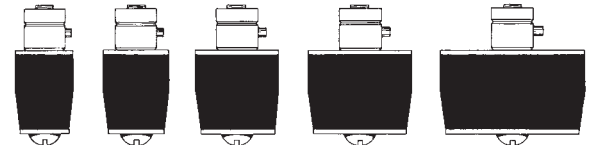

| Model | Length | Part # |
|-----------------|--------|--------|
| X-Pander Wrench | 7" | 302350 |
| | 12" | 302351 |
| | 18" | 302352 |
| | 24" | 302353 |
| | 36" | 302354 |
| | 48" | 302355 |

| Model | Tubing/Pipe Size | Part # |
|---------------|------------------|--------|
| X-Pander Plug | 1/2" | 302333 |
| | 3/4" | 302335 |
| | 1" | 302338 |
| | 1-1/4" | 302341 |
| | 1-1/2" | 302344 |
| | 2" | 302346 |

SERVICE WORK EXPANSION PLUGS

- Can be used for temporary gas shutoff or in a tee during service renewal or installation. 1/2" - 1-1/4" sizes available.

MAIN WORK EXPANSION PLUGS

- Can be used in either bell or spigot end for testing or temporary shut-off. 2" - 6" sizes available.
- 8" standard handle length. 18" and double rubber available by request.
- Overnight plugs.

| Model | Tubing/Pipe Size | Part # |
|---------|------------------|--------|
| Type OA | 1/2" | 302452 |
| | 3/4" | 302453 |
| | 1" | 302455 |
| | 1-1/4" | 302457 |
| | 1-1/2" | 302459 |
| Type A | 2" | 302461 |
| | 3" | 302464 |
| | 4" | 302465 |
| | 6" | 303978 |

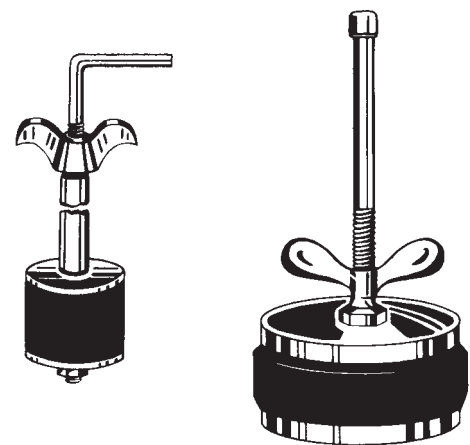

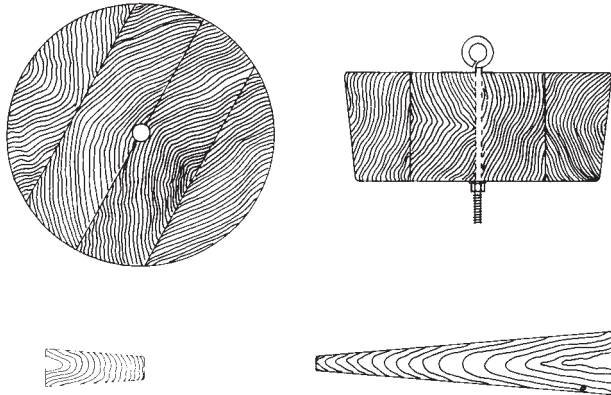

WOOD PLUGS

- Tapered wooden plugs for copper tubing, cast iron, steel and polyethylene pipe.
- 1/2" - 36" available from stock
- Custom sized, designed and fabricated to meet individual specifications.
- Eyebolt package for easy removal available on sizes 8" and up.

| Model | Tubing/Pipe Size | Part # |
|-----------|------------------|-------------|
| Wood Plug | 1/2" - 36" | Please call |

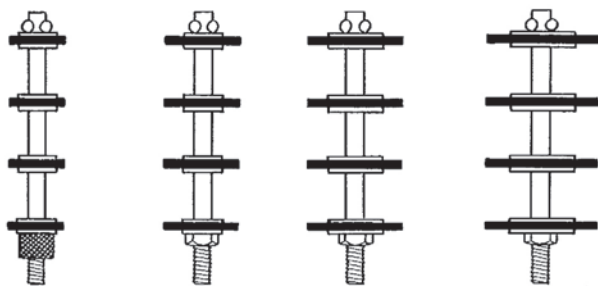

SERVISTOPS

- Shut-off gas flow for pressures not exceeding 2-10 psi.
- Push Servistops into pipe with available t-wrench.
- No expansion necessary.

| Model | Tubing/Pipe Size | Part # |
|-----------|------------------|--------|
| Servistop | 3/4" | 302295 |
| | 1" | 302296 |
| | 1-1/4" | 302297 |
| | 1-1/2" | 302298 |
| | 2" | 302301 |

| Model | Length | Part # |
|------------------|--------|--------|
| Servistop Wrench | 9" | 302302 |
| | 15" | 302303 |
| | 18" | 302304 |
| | 36" | 302305 |
| | 48" | 309857 |



SAFETY MAIN BAGS TYPE "PS"

- Available sizes 2-3", 4", 6", 8".
- All rubber construction.

Please contact us for help in ordering the correct size for your application.

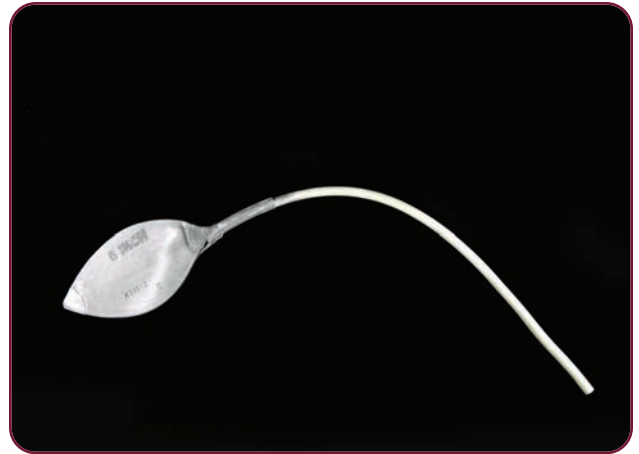

SAFETY MAIN BAGS TYPE "B"

- Available sizes 2" - 48".
- 6 panel rubber construction.
- Nitrile available by request.

Please contact us for help in ordering the correct size for your application.



SAFETY MAIN BAGS TYPE "C"

- Available sizes 2" - 48".
- Canvas covered rubber bags.
- Nitrile available by request.
- Great for cast iron and rough surfaces.
- Optional 0-30# pressure gauge (Part # 303614)
- Pump (Part # 302542)

Please contact us for help in ordering the correct size for your application.



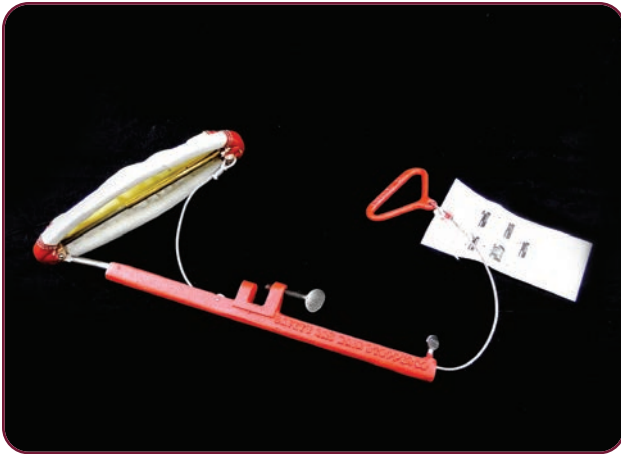

GOODMAN-PEDEN STOPPERS

- Available sizes 2" - 30".
- Spark free brass construction.
- Custom sized for steel and cast iron service.

Please contact us for help in ordering the correct size for your application.

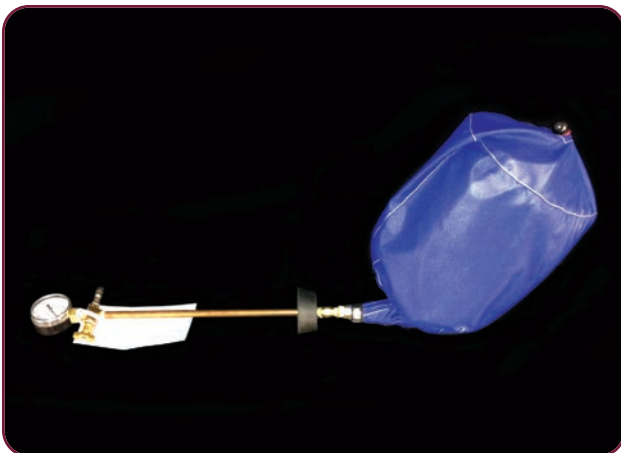

SAFETY DIRECTIONAL GAS BAGS TYPE "D"

- Available sizes 2" - 42".
- Ballistics grade nylon.
- Custom sizes available.
- Straight or 90°.
- Brass directional spine for easy insertion.
- Upstream pressure monitoring available.

Please contact us for help in ordering the correct size for your application.



GARDNER GOODMAN STOPPERS

- Available sizes 2" - 30".
- Brass inflator sold separately.

Please contact us for help in ordering the correct size for your application.



Steel & Cast Iron Pipe Cutting, Beveling & Squeezing

*Mulcare stocks many replacement parts
and offers field service and support
for this equipment.*

PAC28 PIPE AXIAL CUTTER
SOIL PIPE CUTTERS
STEEL SQUEEZE TOOL
HINGED CUTTERS
TRI-POD VISES

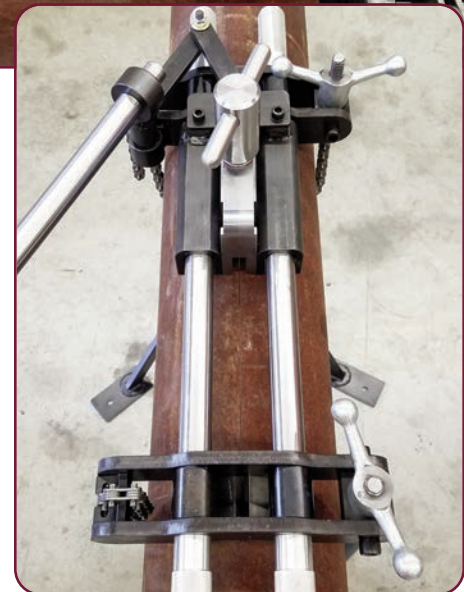
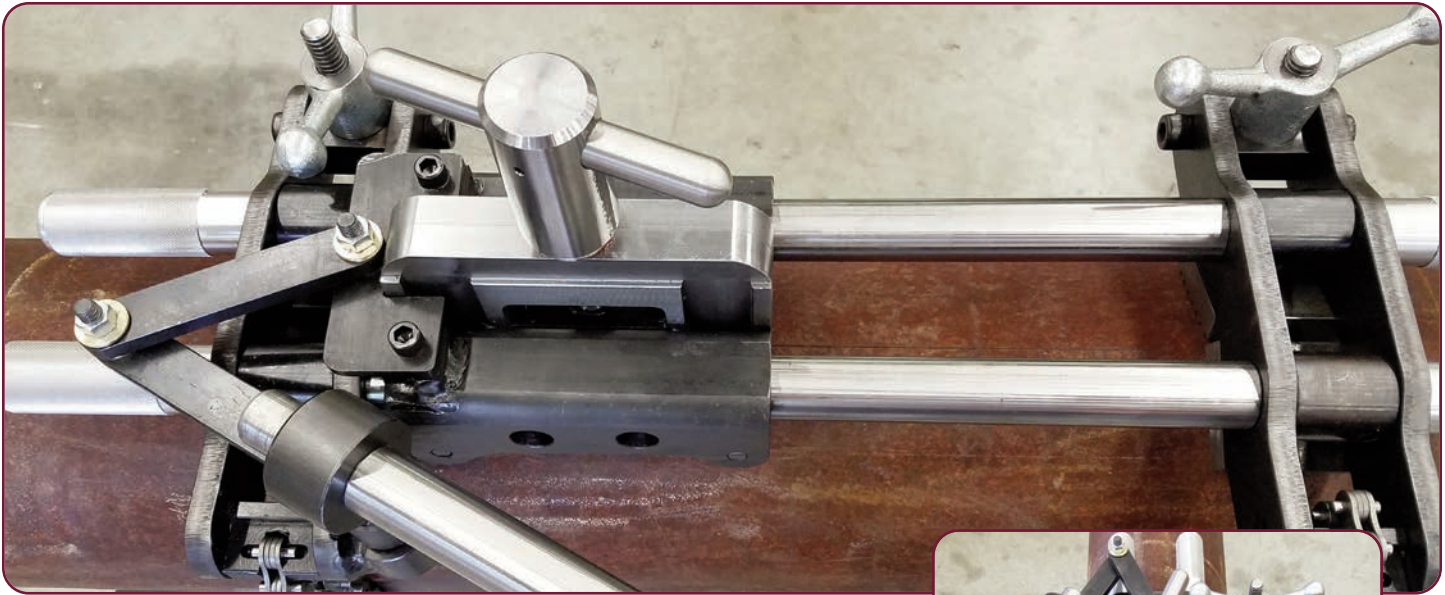

PAC28 AXIAL PIPE CUTTER

- Make spark-less longitudinal cuts on 2" - 8" steel. or cast iron pipe without damaging PE pipe inside.
- Use a standard four wheel cutter. (see below) to effectively remove a section of casing pipe.
- Weighing less than 75 lbs allows for single man operation.
- Rugged machined steel components and hardened cutter wheels.
- Easily field maintained.

| Model | Part # |
|---|--------|
| PAC28 | 304759 |
| Spare Cutter Wheels (2 per tool required) | 304770 |

REED 4 WHEEL HINGED CUTTERS

- Requires only 90° - 100° swing range.
- Only needs 4" clearance around pipe.
- 2" - 12" range.
- Cuts steel, stainless steel, cast and ductile iron.

| Model | Tubing/Pipe Size | Part # |
|-------|------------------|--------|
| H4S | 2" - 4" | 303969 |
| H6S | 4" - 6" | 303349 |
| H8S | 6" - 8" | 304503 |
| H12S | 8" - 12" | 303350 |

Full assortment of replacement cutter wheels available



Call now to place an order
973-335-4800

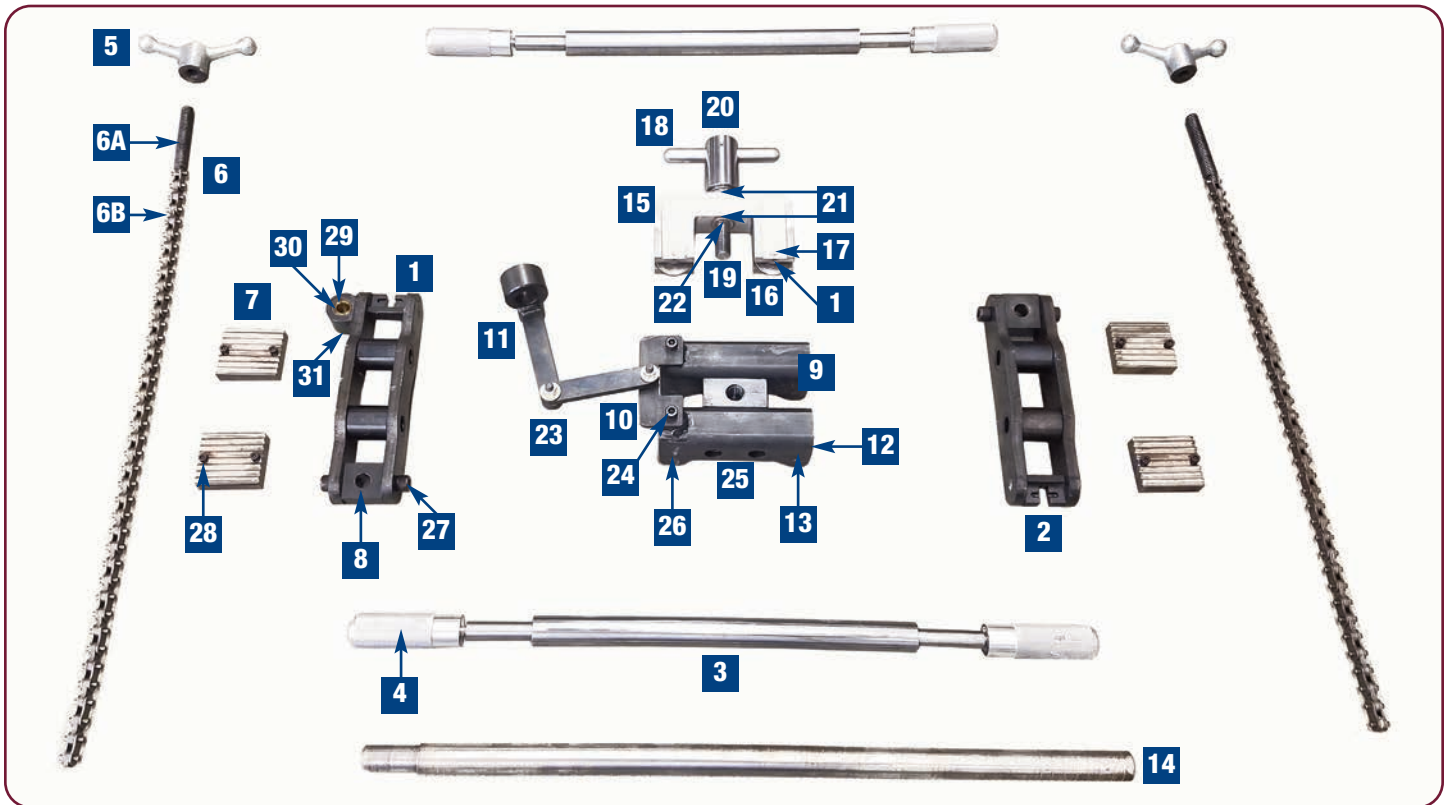

PAC28 REPLACEMENT PARTS

| Ref. No. | Description | Part # | Pieces per tool |
|----------|---|--------|-----------------|
| 1 | Left Support (w/hole for Pivot Link) | 304760 | 1 |
| 2 | Right Support | 310510 | 1 |
| 3 | Support Bar (w/out hand grips) | 304761 | 2 |
| 4 | Hand Grip | 304762 | 4 |
| 5 | Chain Handle | 304763 | 2 |
| 6 | Link Chain and Threaded Rod Screw Assembly | 304764 | 2 |
| 6A | Threaded Rod Screw Assembly | 304766 | 2 |
| 6B | Link Chain | 304765 | 2 |
| 7 | Jaw | 310252 | 4 |
| 8 | Pivot Block | 310253 | 2 |
| 9 | Carriage | 310502 | 1 |
| 10 | Mounting Plate | 304767 | 1 |
| 11 | Pivot Link Assembly (Includes Bolts/Nuts/Washers) | 304768 | 1 |
| 12 | Roller | 301636 | 4 |
| 13 | Roller Pin | 301637 | 4 |
| 14 | Operating Handle | 304769 | 1 |
| 15 | Yoke | 310503 | 1 |

| Ref. No. | Description | Part # | Pieces per tool |
|----------|---|--------|-----------------|
| 16 | Cutter Wheel (Generic wheels can be used but not recommended) | 304770 | 2 |
| 17 | Cutter Wheel Pin | 304771 | 2 |
| 18 | Feed Screw Crank | 310504 | 1 |
| 19 | Feed Screw | 310505 | 1 |
| 20 | Feed Screw Crank Pin | 310506 | 1 |
| 21 | Thrust Bearing | 304772 | 2 |
| 22 | Feed Screw Pin | 304773 | 1 |
| 23 | Bolt/Nut/Washers for Pivot Link Assembly | 304774 | 2 |
| 24 | Mounting Plate Allen Screws | 310255 | 2 |
| 25 | Carriage Screws | 310256 | 1 |
| 26 | Cutter Wheel Retention Screws | 304775 | 8 |
| 27 | Pivot Block Screw | 310257 | 4 |
| 28 | Jaw Allen Screws | 310258 | 8 |
| 29 | Brass Bushing for Left Support | 304776 | 1 |
| 30 | Brass Washers | 304777 | 2 |
| 31 | Snap Ring | 304778 | 1 |





REED SOIL PIPE CUTTERS

- Fastest way to cut cast iron soil pipe.
- Available in single stroke or ratcheting models.

| Ratchet Model | Pipe Size | Part # |
|---------------|------------|--------|
| SC49-6 | 1.5" – 6" | 309065 |
| SC49-8 | 1.5" – 8" | 303847 |
| SC49-10 | 1.5" – 10" | 310630 |
| SC49-12 | 1.5" – 12" | 310631 |
| SC49-15 | 1.5" – 15" | 310632 |

| Single Stroke Model | Pipe Size | Part # |
|---------------------|------------|------------|
| SC59-6 | 1.5" – 6" | REED 08059 |
| SC59-8 | 1.5" – 8" | 310633 |
| SC59-10 | 1.5" – 10" | 310634 |
| SC59-12 | 1.5" – 12" | REED 08062 |
| SC59-15 | 1.5" – 15" | REED 08063 |



REED DESCALER

- Faster and more effective than chisels, chains or files.
- Needs only 2" of clearance around the pipe.

| Model | Size | Part # |
|-------|-----------|--------|
| DS12 | 3" – 12" | 302369 |
| DS36 | 12" – 36" | 303591 |



PS-62B



PS-75

MUSTANG EMERGENCY STEEL PIPE SQUEEZE TOOLS

- Hand operated, lightweight, self contained hydraulic squeeze tools
- Short pump stroke for rapid emergency closure
- Rounded jaw which lessen the chances of severing brittle pipe or pipe of unknown chemistry
- Pressure Relief Bypass System for increased safety
- Latched lower jaw and 90° swivel head

| Model | Tubing/Pipe Size | Part # |
|--------|----------------------------------|--------|
| PS-62B | 3/4" - 2" IPS – 18 tons of force | 304830 |
| PS-75 | 3/4" - 2" IPS – 34 tons of force | 304831 |

Grounding rods are recommended for use during all squeeze operations. Please see page 24 to order.

Polyethylene Valves & Fittings

*Mulcare stocks PE valves and electrofusion fittings
for large utility stock requirements.*

PE PIPE ELECTROFUSION REPAIR

ELECTROFUSION FITTINGS

BRANCH SADDLES

CAMERA FITTINGS

WEAK LINK

POLYVALVES

FOAM PIGS

PIG PEN





NUPI VARIABLE LENGTH REPAIR SLEEVE (VLRS)

The Variable Length Repair Sleeve (VLRS) is a modular system of electrofusion shells that can be installed contiguously and welded on pipes that have notches, scrapes or damage along the axis.

- Rated up to 60 psi.
- Effective on all PE resins.
- Undersaddle clamp included for ease of installation.
- Universal barcode technology to complete fusion.

| Model | Pipe Size | Part # |
|-------------------|---------------|--------|
| Standard Assembly | 2" IPS - 180° | 304820 |
| | 4" IPS - 180° | 304823 |
| | 6" IPS - 180° | 304825 |
| Middle Assembly | 2" IPS - 180° | 304821 |
| | 4" IPS - 180° | 304824 |
| | 6" IPS - 180° | 304826 |
| Jumper Cables | All | 303992 |



NUPI BUTT FUSION REPAIR SLEEVE (BFRS)

The Butt Fusion Repair Sleeve (BFRS) is a safety/repair system to be used to permanently reinforce suspect butt fusion welds.

- Effective on all PE resins.
- Universal barcode technology to complete fusion.
- Clamps and cables sold separately.

| Model | Pipe Size | Part # |
|-------------------|---|--------|
| Standard Assembly | 2" IPS - 360° | 304827 |
| | 4" IPS - 360° | 304819 |
| | 6" IPS - 360° | 304822 |
| | 8" IPS - 360° | 304828 |
| | 12" IPS - 360° | 304829 |
| Installation Kit | Includes wrench, clamps, & jumper wires | 302030 |
| Jumper Cables | All | 303991 |

SEE OUR ELECTROFUSION MEASUREMENT GAUGES ON PAGE 11





NUPI TAPPING TEES

- 1-1/4" - 12" main sizes with 1/2" CTS - 2" IPS outlets available.
- Service and high volume sizes available for SPT & HVPT.
- Unique dual seal, no blow tapping performance.
- Multiple levels of quality control.
- No special installation tools needed; plastic or strap underclamp included with every fitting.

NUPI ELECTROFUSION COUPLINGS

- 1/2" service to 12" main available.
- Multiple levels of quality control.
- Specialty reducers, elbows, tees, and endcaps available.

NUPI CAMERA & BRANCH SADDLES

- Camera fittings come standard with completion plug for a gas tight seal.
- No special tools needed, plastic or strap underclamp included with every fitting.
- Electrofusion branch saddles as large as 12" x 6" available for easy main extension projects.
- NPT series available.

Please contact us for help in ordering the correct size for your application.



WEAK LINK P20

- The Weak Link helps protect pipe during installation. It is designed to yield at a force of approximately 20% less than normal tensile strength of PE pipe.
- It is available in both yellow medium density PE pipe and black high density PE pipe. Sizes from 1/2" CTS to 8" IPS.
- For a complete system, add the Pulling Head and Mud Plug to your Weak Link. The Pulling Head leads your new PE through the bore and the Mud Plug keeps debris out of your pipe during pull back if the Weak Link is compromised.

Please contact us for help in ordering the correct size for your application.





POLYVALVE, LLC

- 1/2" to 12" ball valves available.
- No metal internal parts.
- Bubble-tight shutoff from dual elastomeric seats.
- Fused body shell eliminates leak paths to atmosphere.
- High-grade polymeric materials eliminate corrosion.

We offer a full range of Polyvalve, LLC products. Please contact us for help in ordering the correct size for your application.



FOAM PIGS

- Used for light cleaning, air removal prior to hydrostatic testing, water evacuation and drying.
- Their resilience enables them to negotiate short radius elbows, miter bends, and major diameter reductions.
- Sizes from 2" - 42".

We offer a full range of foam pigs. Please contact us for help in ordering the correct size for your application.



PIG PEN

- Safely collect foam pigs and debris that come out of the gas pipeline while pigging.
- Can be used on multiple PE pipe sizes and easily installs in minutes without the need for additional tools.
- It is durable, reusable, and rolls up in to a compact shape.

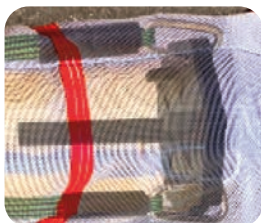

Now with new safety stop plate

| Model | Tubing/Pipe Size | Part # |
|------------|---|--------|
| PPE550-744 | Pig Pen with collar sizes for 2", 4" and 6" PE Pipe | 305374 |
| LC420 | 1-1/4" Add on collar with screw clip | 305715 |
| LC650 | 3" Add on collar with screw clip | 305716 |

Please call for replacement parts.

Marking, Locating & Leak Detection

PE PIPE MARKER & LOCATING SYSTEM
METAL PIPE & TRACER WIRE LOCATORS
TEE'D UP MARKERS
GAS TORNADO
EZ JACK PLUNGER
BAR PULLER
DYNAMIC CONE PENETROMETER
DIGGING BARS
PROBE BARS



3M™ BALL MARKERS

- Depth of up to 5'.
- Unique self-leveling design ensures the marker is always in an accurate, horizontal position.
- 3M-iD markers enable data to be stored in the marker to ensure positive identification of facilities.
- Water resistant polyethylene shells are impervious to minerals, chemicals and temperature extremes.

| Model | Description | Part # |
|---------------------------|--------------|--------|
| EMS Ball Marker 1405-XR | Passive | 302251 |
| iD Ball Marker 1425-XR/iD | Programmable | 303745 |

3M™ ELECTRONIC MARKERS

- Near-surface marker - depth of up to 3' (0.9 meters).
- Mini-markers - depth of up to 6' (1.8 meters).
- Full Range markers - depth of up to 8' (2.4 meters).
- EMS Rope - depth of up to 4' (1.2 meters).
- EMS Marker Tape - depth of up to 2' (0.61 meters).
- Tapping Tee Cap Marker - depth of up to 5' (1.5 meters).

| Model | Description | Part # |
|-----------------------------------|--------------|-------------|
| Near-Surface Marker - 1436 | Passive | 302552 |
| iD Near-Surface Marker 1436-XR/iD | Programmable | Please Call |
| Mini-Marker - 1259 | Passive | 310635 |
| Full Range Marker - 1254 | Passive | 310636 |
| iD Full Range Marker - 1254-XR/iD | Programmable | Please Call |
| EMS Rope - 7705-HTS-Gas | Passive | 304415 |
| EMS Marker Tape - 7615-XR-Gas | Passive | 310637 |
| Tapping Tee Cap Marker | Passive | Please Call |

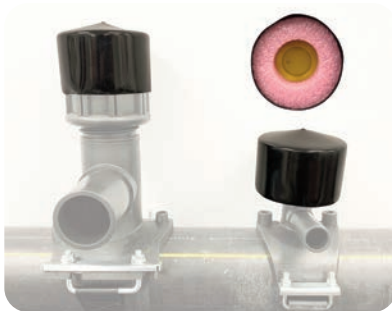

3M™ DYNATEL™ X-SERIES MARKER SYSTEM LOCATORS

- Pinpoint the depth and location of all existing models of properly installed underground passive EMS markers.
- Locate, read and write to 3M iD markers.
- Conduct direct depth reading of markers.
- GPS and Bluetooth enabled.

| Model | Part # |
|-----------------------------------|-------------|
| Dynatel™ iD Locator 1420X | 307644 |
| Dynatel™ Cable/Pipe Locator 2573X | Please Call |
| Dynatel™ iD Locator 7420X | Please Call |





TEE'D UP MARKER

- Gives excavating operators early notice of buried utilities
- Embedded magnet makes it easy to identify the location above ground using a standard metal locator
- Modular design accommodates multiple applications

| Model | Length | Part # |
|---------|-------------------------------------|--------|
| TMST-ST | Direct Pipe Application Kit | 310638 |
| TMTT-PC | Tap Tee Application Kit | 310639 |
| TMHV-C | High Volume Tap Tee Application Kit | 310640 |
| TM01-3M | Peg Base Kit | 310646 |



GAS TORNADO

- Using the Venturi effect, this tool aggressively suctions gas from the ground. It generates 242" of simultaneous dry/wet pick-up power.
- No moving parts, no spark and no motor maintenance.
- Can be used in less than 2" diameter holes at any depth

| Model | Length | Part # |
|----------------|--|--------|
| T95993UNIT | Complete unit (includes power head & lower unit) | 304571 |
| T95993UNIT-TIP | Complete unit w/ threaded insert plug (includes power head & lower unit) | 305419 |



Grounding rods are recommended with use. Please see page 28 to order.

EZ JACK PLUNGER

- One-Man Probing Tool with 52" Probe Depth
- Tempered Steel or Fiberglass Rod Options
- Comes with Oversized Replaceable Tips
- Sturdy, Plastic Coated (PVC) Handles

| Model | Length | Part # |
|------------|--|--------|
| EZ1006 | Heavy Duty - Standard Handle with Steel Rod | 305679 |
| EZ1005 | Heavy Duty - Ergo Handle with Fiberglass Rod | 310641 |
| EZ1004 | Utility - Ergo Handle with Steel Rod | 305678 |
| EZ1004F | Utility - Ergo Handle with Fiberglass Rod | 309150 |
| EZTIP-1116 | Replacement Tip - 11/16" Screwed Ball Tip* | 310642 |
| EZ1005HO | Replacement Handle - Heavy Duty Ergo Handle* | 310643 |

*Are interchangeable with Heath models





| Model | Part # |
|------------|--------|
| Bar Puller | 304920 |

PERC BAR PULLER

- All welded steel design.
- Lightweight at less than 20 lbs. total weight.
- Designed for one man operation.
- Prevents pavement cracking.
- Eliminates bar bending caused by other removal methods.
- Adjustable to bar/pin diameters of 1/2" - 1-1/4".
- Pull stuck pneumatic tool bits from pavement and concrete.
- Works on all ground surfaces during all seasons.

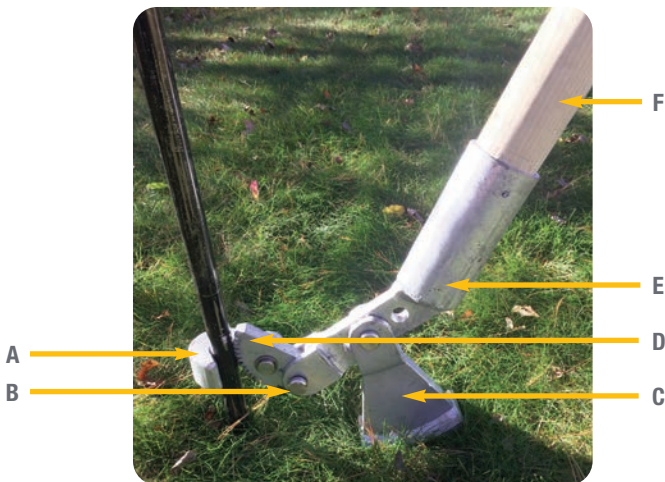

REPLACEMENT PARTS

| Ref | Description | Part # |
|-----|------------------------------------|--------|
| A | Hook | 301638 |
| B | Hook/Jaw/Rocker Pin with Snap Ring | 301562 |
| C | Rocker | 301640 |
| D | Ratchet Jaw | 301639 |
| E | Lever | 301641 |
| F | Ash Wood Handle (6') | 301148 |



DCP

- Verify compaction at any lift level during backfill.
- Reduce or eliminate costly tests by soil laboratories.
- Satisfy city and county requirements.

| Model | Part # |
|--|--------|
| DCP Kit (includes case and moisture meter) | 302909 |
| Moisture Meter | 303774 |
| Spare Tips | 308979 |



PROBE BARS

- Sizes 3' – 8' lengths.
- Heat treated hexagon steel shank.
- Offered in different materials and sizes.
- Fishtail probe bar available.

| Model | Length | Part # |
|------------------------|---------|-------------|
| Tee Handle Probe Bar | 3' – 8' | Please Call |
| Single Point Probe Bar | 3' – 8' | Please Call |



DIGGING BARS

- Sizes 2' – 8' lengths.
- Steel shank with hard faced edge for better wear.
- Top of digging bar can be used to tamp the ground.

| Model | Length | Part # |
|-------------|---------|-------------|
| Digging Bar | 2' – 8' | Please Call |





Mustang DBH1200B being lowered for use on a 8" SDR9 live main.

Located on Page 23

STATIKIL PE
GROUNDING ROD
LLFA TAPE PIPE REPAIR SYSTEM
CADWELD
BONDING CABLES
SOAP CANS
SCOTCHRAP PIPE WRAP
SCOTCHKOTE PRIMER
ANTI-THEFT/STOPPER PLUG
VALVE BOX LIDS, PLUGS, EXTENSIONS
RETZ REGULATOR TOOL
METER NUT WRENCH
BEYER BOX
LINK SEALS PENETRATION SEALS
CASING ISOLATORS
END SEALS
WARNING TAPE



Excellent visibility on all PE pipes



- Effectively eliminates static charges on PE gas pipe by increasing surface conductivity
- Eliminates need for bulky burlap or pipe wraps
- Keeps work area clear and eliminates trip hazards posed by other grounded pipe “wraps”
- To be used prior to construction operations including squeeze-off, repair, tapping, cutting, venting, etc.
- Colorant added for positive verification of product coverage
- Remains effective even after pipe is dry
- No aerosols. No wasted over spray.

Product available ready for use in:

- 32 oz spray bottle with simple trigger spray for accurate application. (Part # 301000)
- 1 Gallon containers (Part # 301813)

| Specifications | |
|-------------------|--|
| Composition | High Molecular Weight Topical Antistat |
| Physical Form | Liquid |
| Color | Gray Pigment for Visibility |
| Flash Point | None |
| Freeze Point | -10° F |
| Explosion Hazard | None |
| Specific Gravity | 1.0 |
| Odor | Mild Lemon |
| pH Regular | 7.71 |
| Static Decay Rate | MIL-B-81705-B At Relative Humidity @13% 72°F .35 Sec @5 KV |

STATIKIL PE has been tested by independent laboratories and meets or exceeds ASTM D-257-80, MIL B-81705-B, Electronic Industry IS-5 and NFPA-99 specifications for surface resistivity and static decay.



ProReach128 (one gallon) long reach sprayer accessory available for above ditch applications (Part # 306035)

| | |
|-----------------|-------------------|
| Health 0 | Flammability 0 |
| Reactivity 0 | |



PLEASE VISIT WWW.STATIKIL.COM TO SEE A VIDEO OF STATIKIL PE IN ACTION!

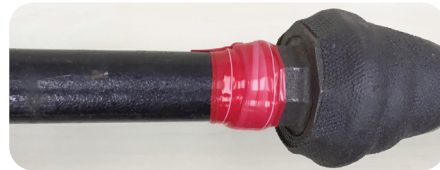
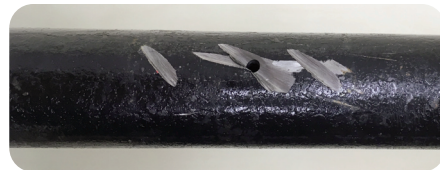

LLFA® TAPE

LLFA Tape is a self-fusing silicone based tape designed to seal leaks in harsh weather conditions and is currently used as a temporary or permanent repair for natural gas leaks.

- LIVE leak sealing <150psi on PE, Steel, Copper, Cast Iron, SST, etc.
- One-step, straightforward application with minimal prep time.
- Stable from -130°F to 500°F (-90°C to 260°C).
- Highly UV & Ozone resistant.
- No storage requirements, 4 year shelf life.

LLFA® SMOOTH

Fast-acting insulating putty that stays flexible and works well in conjunction with LLFA Tape.

- Fill rough and/or uneven surfaces before using LLFA Tape.
- Molds quickly and easily, without the use of gloves or chemicals.

LLFA® GARDE

Moisture cure polyurethane infused fiberglass tape for extra protection of LLFA Tape in extremely aggressive/abusive environments.



RESOURCE LIBRARY

| Model | Description | Part # |
|---------------|---------------------------|--------|
| LLFA Tape | 1" x 40mil x 36ft (Red) | 301819 |
| | 1" x 40mil x 36ft (Black) | 301822 |
| | 2" x 40mil x 36ft (Red) | 301824 |
| | 1" x 40mil x 12ft (Red) | 301820 |
| LLFA Smooth | 4oz, 113g (Standard) | 301826 |
| | 3oz, 100g (Thin) | 301828 |
| | 4"X 6" (Brick) | 301830 |
| LLFA Garde | 3" x 5' | 306047 |
| | 3" x 12' | 306048 |
| | 4" x 12' | 307618 |
| V65 Tensioner | 2" Tape Tensioner | 301832 |





CADWELD® IGNITERS, ADAPTERS & ACCESSORIES

- Install exothermically welded connections.
- Options available for keyhole applications

| Cadweld® Pulse Impulse Igniter | Part # |
|--------------------------------|--------|
| Igniter with 6' cord | 306267 |
| Igniter with 15' cord | 306268 |

| Cadweld® Mold Adapter | Part # |
|---|--------|
| Steel Pipe Mold 3/4" - 3-1/2" diameter pipe | 304098 |
| Steel Pipe Mold 4" and larger diameter pipe | 304097 |

| Cadweld® Accessories | Part # |
|---------------------------------|-------------|
| Copper Sleeves (Package of 100) | Please Call |
| Mold Cleaner Brush | 304126 |
| Mold Cleaner Scraper | 304125 |
| Flint Gun | 304614 |
| Pipe Clamp - Magnetic | 304099 |
| Cadweld Shots | Please Call |



Standard Magnetic Ends

Spring Clamp Ends

BONDING CABLES

Maintain continuity between two pipe sections when welding to ensure both have adequate path to ground for safe and effective welds.

| Lengths Available | Part # |
|--|--------|
| 6' Bonding Cable Assembly (Magnetic) | 304925 |
| 10' Bonding Cable Assembly (Magnetic) | 304923 |
| 20' Bonding Cable Assembly (Magnetic) | 304924 |
| 6' Bonding Cable Assembly (Spring Clamp) | 306683 |



SOAP CANS

- Metal construction with built in brush.
- Pint & quart sizes available.

| Sizes Available | Part # |
|--------------------------------------|--------|
| Pint Size Metal Soap Can with Brush | 302929 |
| Quart Size Metal Soap Can with Brush | 302930 |





UTILITYLOGIC VALVE BOX LOGIC SYSTEM

Complete with lockout protection against unauthorized access, bi-directional locating magnet or optional 3M EMS Disc, includes generic valve identification tag. (Custom utility identification tags upon request)

Please contact us for help in ordering.

LOGIC LIDS

The Logic Lid is an alternative to conventional cast iron valve box lids. They help eliminate noise complaints in residential neighborhoods as well as limit liability costs often associated with roll-out or pop-out problems.

- High-impact fiberglass and reinforced nylon design helps prevent pop-outs.
- Water and debris proof.

Please contact us for help in ordering.



LOGIC PLUGS

The Logic Plug keeps the pipe and valve dirt free and prevents unauthorized operation of the valve. It works in conjunction with valve maintenance programs and lock-out / tag-out programs. Available for all major brands of valve boxes.

Please contact us for help in ordering.



LOGIC EXTENSION

The Logic Extension adds the extra reach needed to access the valve operating nut with the standard tools you already have. Extensions can be completely assembled at an exact length or top open ended for field customization.

- 2" x 2" x 1/4" reinforced fiberglass riser shaft.
- Field customizable shaft height. (order in foot increments up to 12')
- Standard debris catcher top with optional fine mesh available.
- 2" square operating nut end.

Please contact us for help in ordering.

**Easily customize shaft length in the field with a Sawzall.*





VALVE BOX ANTI-THEFT

- Expandable EPDM plug blocks pipeline against tampering and gas theft.
- Standard diameters of 3-1/2" to 8-1/2".
- Custom sizes can be ordered upon request.
- 36" wrench sold separately.

We offer a full range of Goodman products. Please contact us for help in ordering the correct size for your application.



3M SCOTCHRAP

- PVC tape with a high-tack adhesive provides a corrosion- and impact-resistant seal for all-weather protection of metal piping systems above and below ground.

| Model | Size | Part # |
|-----------------|-------------------|--------|
| 3M Scotchrap 50 | 10 mil, 1" x 100' | 302545 |
| | 10 mil, 2" x 100' | 302546 |
| | 10 mil, 4" x 100' | 302547 |



3M SCOTCHRAP PIPE PRIMER

- A quick-drying, non-sag rubber base primer that permeates metal surface pits and irregularities, preparing the surface for tape application

| Model | Size | Part # |
|-----------------------|--------------|--------|
| Scotchrap Pipe Primer | 1 gallon can | 302548 |



EMPIRE LEVEL NON-DETECTABLE WARNING TAPE

- Durable, dependable non-detectable polyethylene warning tape for service and other non-critical metallic installations.
- Installed at proper shallow depth, ShieldTec is tough, basic protection for any type of buried cable or pipe. Suitable for open trench installation.
- Custom artwork available.

| Model | Size | Part # |
|-------------------------------------|------------|--------|
| Yellow with Black Type Caution Tape | 3" x 1000' | 302435 |
| | 6" x 1000' | 302436 |



EMPIRE LEVEL REINFORCED NON-DETECTABLE WARNING TAPE: DURATEC®

- Premier non-detectable **woven** polyethylene tape.
- Patented reinforcing weave provides the strength needed for plowed-in installations.
- Will not stretch when dug into; the printed message stays intact and is easy to read.

| Model | Size | Part # |
|-------------------------------------|------------|--------|
| Yellow with Black Type Caution Tape | 3" x 1000' | 303159 |



EMPIRE LEVEL PREMIUM DETECTABLE WARNING TAPE: MAGNATEC

- The premium detectable tape used for location and early warning protection for underground lines.
- Middle foil layer allows for both inductive and conductive locating.

| Model | Size | Part # |
|--|------------|--------|
| Yellow/Silver, Black Type Caution Tape | 2" x 1000' | 308949 |
| | 3" x 1000' | 310644 |
| | 6" x 1000' | 310645 |





LINK SEALS

- Modular seals are used for permanently sealing pipes of any size passing through walls, floors and ceilings.
- Ductile iron, concrete, metal as well as plastic pipes may be hydrostatically sealed within walls to hold up to 20 psig (40 feet of static head).
- Seals are available for a wide variety of special applications, temperature extremes, exotic chemical combinations and for “out-of-round” or non-centered applications.

Please contact us for help in ordering the correct size for your application.

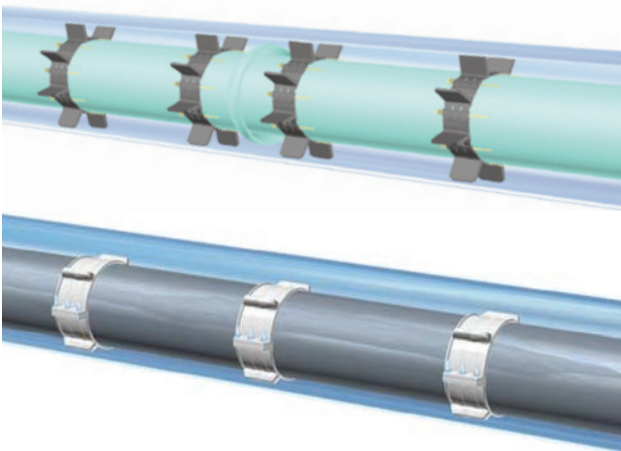

CASING ISOLATORS

- The Ranger II® is an entirely non-metallic casing isolator/spacer system that uses molded segments to encircle the carrier pipe.
- Model PE is a high density (linear), injection molded, virgin polyethylene casing isolator/spacer for a wide variety of double containment carrier/casing pipe applications.

Please contact us for help in ordering the correct size for your application.

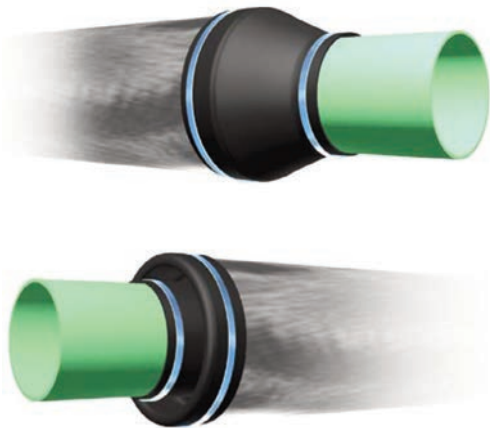

MODEL "C" END SEALS

- Model "C" custom pull-on end seals are made to customer supplied specifications so they may be used for any size casing/carrier differential.

MODEL "S" STANDARD PULL-ON END SEALS

- Model "S" standard pull-on end seals are flexible and easily installed on nominal steel & IPS casing/carrier pipe combinations.

Please contact us for help in ordering the correct size for your application.



Meter Set Tools & Components

METER NUT WRENCH
BEYER BOX
RETZ REGULATOR TOOL
BREAKAWAY VALVE



MD-52 METER NUT WRENCH

- Made from 304 stainless steel.
- Nickel plated.
- 7 sided jaws properly sized to minimize damage to meter nuts.
- Multi-purpose with a meter nut wrench and meter valve adjustment feature.

| Model | Description | Part # |
|---------|--|--------|
| MNW10 | For 10 LT Meter Connection Spud | 305521 |
| MNW1A | For 1A LT Meter Connection Spud | 310170 |
| MNW20 | For 20 LT Meter Connection Spud | 305522 |
| MNW30 | For 30 LT Meter Connection Spud | 305523 |
| MNW45 | For 45 LT Meter Connection Spud | 305524 |
| MNWOX30 | Dual sided. Used with 20 LT and 30 LT Meter Connection Spud. | 305520 |

Multi-size kits available



BEYER BOX - EASY VALVE ACCESS

- Establishes and protects access to the meter set valve.
- Eliminates the high cost to raise the service line and riser.
- Installation is simple and fast, a one man job.
- Minimizes disturbance to existing landscape.
- Establishes a safe installation with access to valve and no need for cathodic protection or anodeless riser service.
- Optional cover to offer long-term protection.

| Model | Description | Part # |
|------------|-------------|--------|
| GARB16X16 | Box & Lid | 305358 |
| GARB16X16B | Box Only | 305594 |
| GARB16X16L | Lid Only | 305626 |



RETZ REGULATOR TOOL

Universal dual-sided tool adjusts set points on most residential (hexagon end) and commercial (flat head end) regulators.

- Lightweight and compact, Aluminum anodized finish to eliminate rusting.
- Hexagon shaped body to accept crescent wrench, Torque hole for stubborn regulators.



| Model | Part # |
|---------------------|--------|
| RETZ Regulator Tool | 309158 |

HALO VALVE

The HaloValve is a Natural Gas Safety Breakaway, which can be easily integrated into existing installations, it is placed in the riser pipe between grade and the gas meter. Upon impact, the valve disconnects and gas flow is shut off, which provides instant and effective protection from the accidental rupture of gas meter lines.

Additionally, the HaloValve enables utility companies to comply with the requirements of the PIPES Act legislation of 2020 by helping eliminate the accidental emission of greenhouse gases into the atmosphere.

- The breakaway is installed into the meter set or other gas piping.
- Design withstands nominal lateral forces.
- If a significant lateral force occurs, the fitting breaks.
- The ball acts as a plug stopping the escape of gas.
- Stopping the flow of natural gas minimizes risk of fire, explosion, property damage and serious injury.

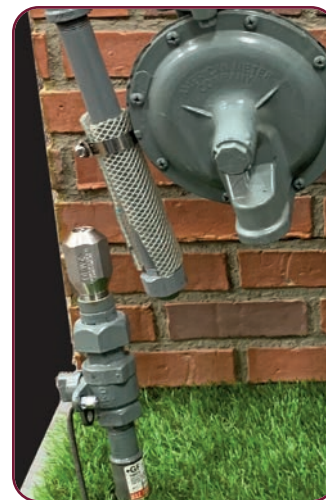
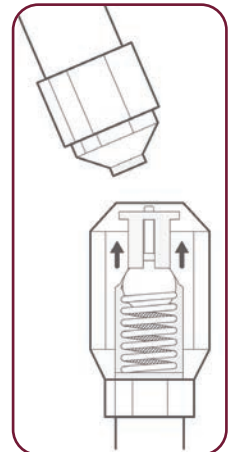
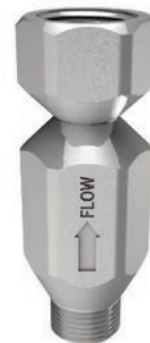

| Model | Size | Part # |
|-----------|------|-------------|
| HaloValve | 3/4" | Please Call |
| | 1" | Please Call |

Available in 4" & 6" lengths and any combination MNPT or FNPT connections.





Using the GoVAC Flex for cross compression from a decommissioned main into a newer one.

Located on Page 73





Methane Emissions Reduction

GOVAC FLEX
GOVAC MAX



GOVAC® FLEX

SYSTEM FOR PIPELINE EVACUATION
AND CNG COMPRESSION



SELF-CONTAINED, FULLY-AUTOMATED, NO EXTERNAL POWER REQUIRED

The GoVAC® FLEX system gives natural gas operators the ability to adopt best practices for performing natural gas capture and recovery during pipeline maintenance and other applications. In addition, the system can be used for natural gas vehicle refueling, station backup and filling tube trailers.

Our patented, portable, natural gas compressor offers a safe and practical solution that prevents methane emissions in achieving your company's environmental goals.

Freedom from External Power

No diesel, electricity, or any other fuel source required in its operation. The system runs on the natural gas it is evacuating from the pipeline.

Flexibility in Siting

Hazardous area compliant and can operate near pipelines without the need for external diesel generators or air compressors.

Portability/Mobility

Small enough to be pulled by a pickup. The self-contained, integrated system is easy to maneuver around a job site and requires no extra equipment.

Environmental Reporting

The intuitive control system provides operators with validated environmental reports and operational metrics.

Flexible Inlet/Outlet Pressures

The GoVAC® FLEX system can draw a pipeline from 1250 psig (*higher pressures optional*) to near 0 psig and transfer into an adjoining pipeline or a tube trailer at pressures up to 3600 psig.

24/7 Remote Monitoring

The GoVAC® FLEX system is equipped with cellular telematics which allows for remote operations monitoring and two-way communications.

FOR SALE, LEASE, OR AS A TURNKEY SERVICE





GOVAC[®] MAX

PIPELINE EVACUATION SYSTEM

High Capacity Pipeline Evacuations

The GoVAC[®] MAX system is a self-contained natural gas capture and recovery solution that eliminates the need for flaring or venting during pipeline blowdowns. The GoVAC[®] MAX system is built on our patented compression technology so it runs on the natural gas being evacuated from the pipeline. This reduces the emission profile to a minimum and removes the need for additional equipment for natural gas recovery.

Operational Benefits and Advantages

- » High flow rates for fast evacuation of large projects
 - » Up to 500 scfm
 - » Up to 1000 psig inlet/outlet pressure
- » Optimal performance and size for many applications
- » Easy to operate and maintain
- » Internal tool and hose storage
- » Low noise
- » Intuitive and easy to read control panel
- » Remote monitoring
- » Automated controls and data capture
- » Validated environmental impact reporting

Average MSCFD Transferred Based on Pipeline Starting Pressure

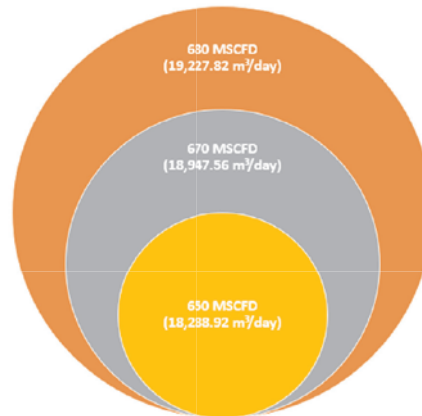

Starting pressure

- 1000 psig (6.89 Mpa) ●
- 750 psig (5.17 Mpa) ●
- 500 psig (3.45 Mpa) ●

Projects evacuated down to 1 psig (6.895 kPa)

Fully Automated, Digitized Evacuation

The control system provides automated data capture and ensures safe and tamper-proof transmission, storage and secure access. Accurate and validated environmental and operational reporting on key metrics are available to the operators both on site and remote. This digitized evacuation capability enables companies to comply with current and future regulations and meet environmental initiatives.





1923
2023
100
years

*Delivering
Natural Gas
Innovation...*

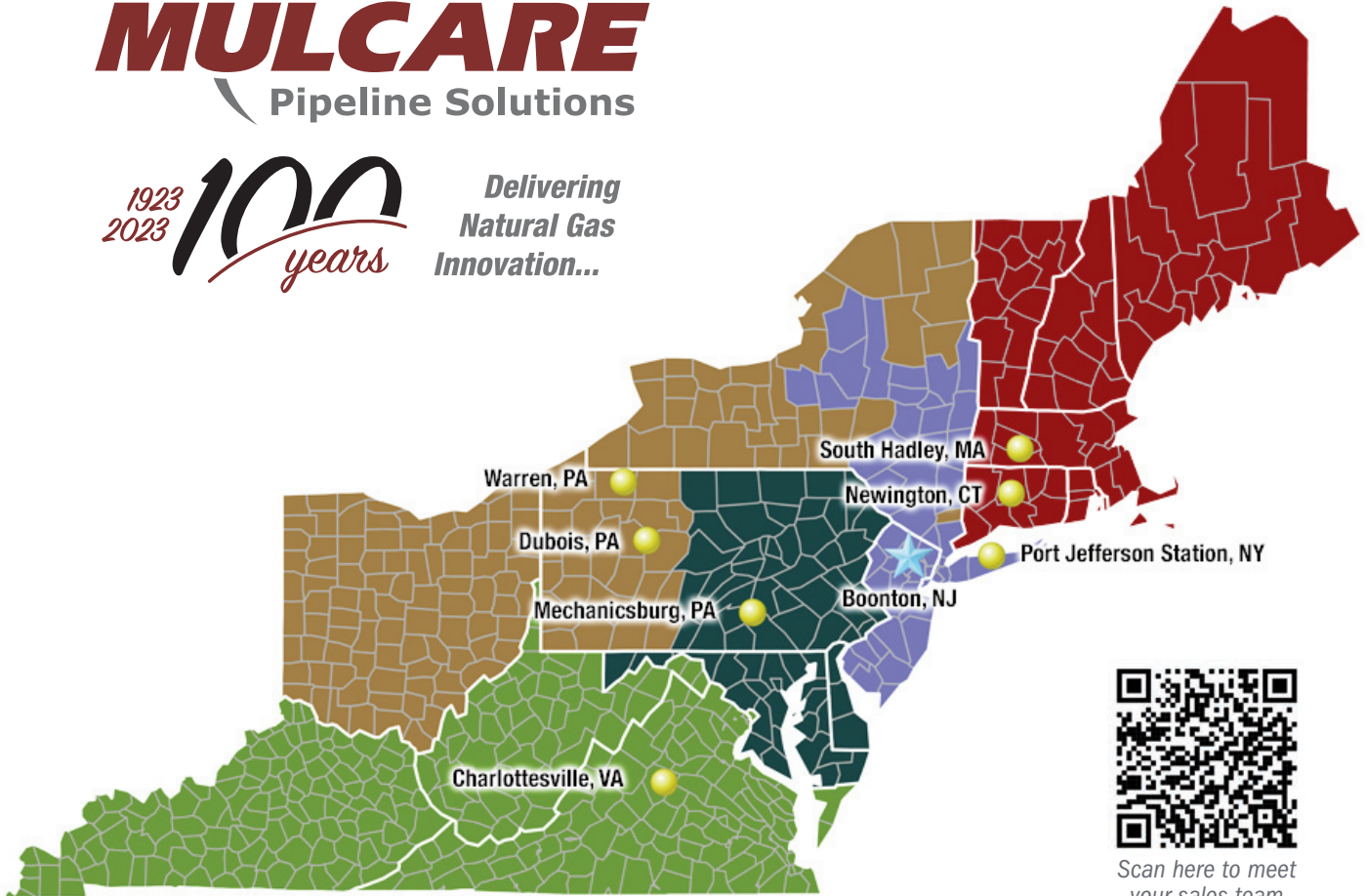

*Scan here to meet
your sales team*



*Scan for
Online Catalog*

Mulcare operates from eight regional offices employing 5 Regional Sales Managers, 4 Tooling & Distribution Territory Managers, 2 Product Managers, 4 Project Managers, 6 Inside Salespersons, and over 20 additional support personnel.

Our traditional principals' products are offered within all the New England States, New York, New Jersey, Pennsylvania, Delaware, Maryland, Virginia, West Virginia, Ohio and Kentucky. With a 28,000 sq./ft corporate headquarters and warehousing in Boonton Twp., NJ, we are 1-day shipping time to our customers' locations and only hours away from each of our service centers.

Contact us with questions, to place an order or schedule a demo.

Corporate Office
9 Mars Court
Boonton, NJ 07005
t: 973-335-4800
f: 973-402-1558
info@mulcare.com
www.mulcare.com



1923
2023
100
years

Delivering
Natural Gas
Innovation...

Corporate Office
9 Mars Court
Boonton, NJ 07005
t: 973-335-4800
f: 973-402-1558
info@mulcare.com
www.mulcare.com



Mulcare Pipeline Solutions. Since 1923, Mulcare has grown with the natural gas industry by delivering cutting edge equipment and services that consistently surpass expectations. We are focused and well-versed on the modern concerns of transmission and distribution companies, municipalities and contractors alike. Whether you require the industry's latest and most advanced products, on-site experts, money-saving solutions or all of the above, Mulcare can meet your needs.

Our Objective. We are committed to creating rewarding partnerships with our customers and principal suppliers. These relationships have yielded the industry's leading offering of products, equipment, tools and expertise: all the things necessary to compete in today's dynamic natural gas industry. We can lower your costs and design solutions for the installation, operation and maintenance of natural gas infrastructure.

Our Strengths. Industry experts focused in these areas:

- Commercial, Industrial & Residential Metering
- Commercial/Residential AMI/AMR (Itron ERT® Reader)
- Flow Control Valves & Pressure Regulators
- Gas Chromatography & Sampling Systems
- Odorant Injection, Detection & Analysis Equipment
- Dry & Coalescing Filters
- Pipeline & Instrument Heaters
- Polyethylene & Steel Valves
- Hot Tap & Flow Stop Equipment
- Electrofusion & Butt Fusion Systems
- Pipe Installation & Repair Tooling
- Underground Marking & Locating Systems
- Methane Emissions Reduction
- Cross Compression/Pipeline Gas Evacuation Equipment
- Cross Compression/Pipeline Gas Evacuation Service
- Field Installation, Start-up & Maintenance Services

Contact us today. Let us demonstrate how over 100 years of experience can help you meet your challenges head-on and reach your long-term goals: on time, on budget and ahead of the curve.